

Technical documentation

telecommunication server IP-PBX

Slican IPS-08

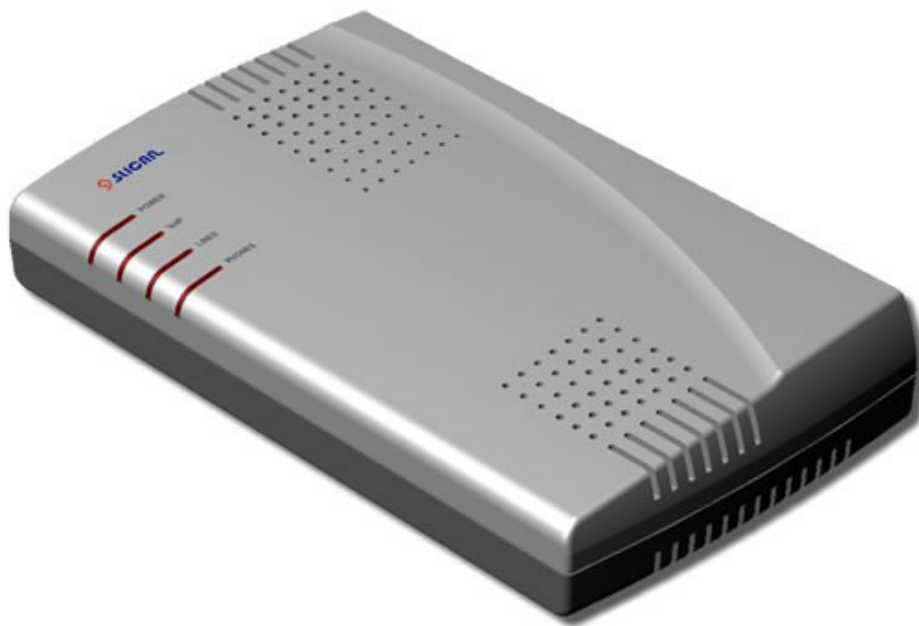

Release 1.05



PRZEDSIĘBIORSTWO
FAIR PLAY

SLICAN Sp. z o.o.
www.slican.pl
e-mail: office@slican.pl

IPS-08 includes software made available in accordance with GNU General Public Licence, Mozilla Public License and BSD licences. The content of the licence is included on an attached CD.

"The manufacturer reserves right to modify the product without prior notice".

Date of last modification: 4.08.2015

Contents

1 General.....	4
2 Basic parameters and features of Slican IPS-08 telecommunication server.....	4
2.1 Hardware versions.....	4
2.2 Functional features.....	4
2.3 Specifications.....	5
3 Instalation.....	6
3.1 Server mounting.....	6
3.2 Server versions (slot/port view).....	6
3.3 AB, CO ports (RJ-11 connector).....	6
3.4 SN/RL port (sensor/relay) (RJ-11 connector).....	7
3.5 GSM port.....	8
3.6 LAN port(RJ-45 connector).....	8
3.7 SET button.....	9
3.8 Power connector.....	9
3.9 Description of LED's on the front panel.....	10
4 microSD card mounting.....	11
5 Safety requirements for operating IPS-08 servers.....	12
5.1 Instalation requirements.....	12
5.2 Workplace Environment.....	12
6 Certificate of Conformity and Correct Product Disposal.....	13

1 General

The Slican IPS-08 telecommunication server is characterized by flexible configuration possibility. It is available in small, wall-mountable version, which makes it ideal for small companies, offices and private houses.

Depending on the versions, IPS-08 server works with:

- analog devices (telephones, fax machines, modems)
- analog public lines (POTS)
- VoIP equipment and software (SIP)
- VoIP operators (SIP)
- GSM operators

2 Basic parameters and features of Slican IPS-08 telecommunication servers

2.1 Hardware versions

IPS-08 server comes in various configuration versions, without change/extensions possibility. The following models are available:

Model	Number of ports				Number of channels	
	Subs	CO	GSM	SN/RL	VoIP	Rec
IPS-08.100	8	-	-	-	8 (16xSubsVoIP, 8xTrVoIP)	8
IPS-08.101	4	1	1	1	8 (16xSubsVoIP, 8xTrVoIP)	8
IPS-08.104	2	-	1	1	2 (8xSubsVoIP, 8xTrVoIP)	0
IPS-08.105	4	1	-	-	4 (8xSubsVoIP, 8xTrVoIP)	0

Where:

- **Subs** - internal analog line port with the decade (pulse) or tone (DTMF) dial, which is connected to the phone / fax / modem, etc.
- **CO** - external analog POTS trunk port (compatible with ASS signaling) which is connected to a line from public PBX.

Electrical parameters:

- **GSM** – GSM trunk port (Tri-Band 900/1800/1900 MHz) for voice calls and text messages directly to the cellular network.
- **SN/RL** - port allows you to use the server to perform the function of automation and notification.
- **VoIP** - subscriber/trunk port compatible with VoIP SIP protocol(v.2.0) that logs into your VoIP operator, or log on to the SIP client and protocol Essl (Slican Smart Link) allows you to link the IPS-08 server with other SLICAN servers.
- **Rec** - call recording feature (requires the installation of a microSD card into the server, see section 4).

2.2 Functional features

- Support for Slican IP and SIP system telephones
- cooperation with CTI modules packages (PhoneCTI, WebCTI, ConsoleCTI)
- open HTTP / EbdRECP / TAPI / HOTELP / XML / CTIP protocols
- VoIP support
- advanced remote management and costs control

- integrated GSM
- LAN linking (SIP, eSSL)
- Embedded Call Recording
- control of external devices
- configuration through ConfigMAN
- real-time monitoring using managing application,
- voice announcements (DISA/Infolines DND message),
- subscriber services confirmed with voice messages,
- cooperation with PC applications,
- support for Slican doorphones and Slican DPH access control system
- internal CLIP signalling and transfer of public signals.

2.3 Specifications

- power from the mains ~230V AC, 50Hz via the included external power supply 12V / 1,4 A,
- power consumption: 2,4 W in standby mode, max.: 14W - if all the phones are ringing simultaneously,
- extensions and urban surges security, coming from the telecommunication network,
- LAN port (Ethernet 10/100 with auto MDI / MDIX) for VoIP calls and programming
- housing dimensions 191x111x36 mm,
- subscriber lines AB electrical parameters: 32V voltage, current 20.7 mA, voltage 45V 50Hz tone (sine)
- CO trunk electrical parameters: isolation resistance measured at the terminals to each other and to ground at 100V should be $\geq 10 \text{ MW}$,
- line lenght:

Line type	Range
AB (analog subscriber)	The maximum length of the line connecting the phone to the server should not be greater than 1000 m
CO (public analog line)	According to PTR – Provider’s Technical Requirements (TP S.A.) - the maximum loop resistance for direct current: 1800 Ω with the end-use device. (only for 1200 Ohm cable)
LAN	100 m – only for an unshielded twisted-pair wire, class 5 (length of cable between the devices; VoIP subscriber can be located in any area)

3 Instalation

3.1 Server mounting

The server is designed to hang on the wall in horizontal or vertical position with the help of two dowels Ø 6 Dowel screws must be screwed so that their heads protrude approximately 5mm from the wall. In the middle of the instructions is a template showing the mounting holes and dimensions of the server.

3.2 Server versions (slot/port view)

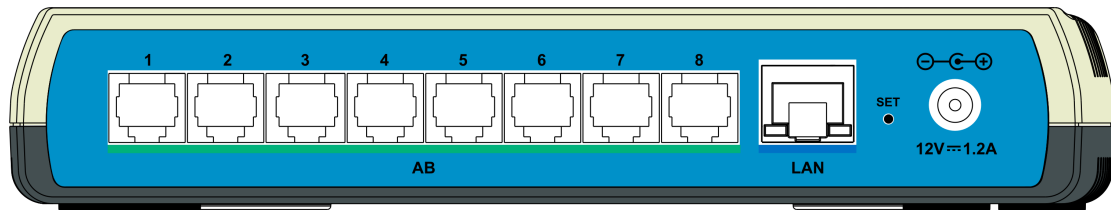

Figure 3.2.1.: Available IPS-08.100 server ports

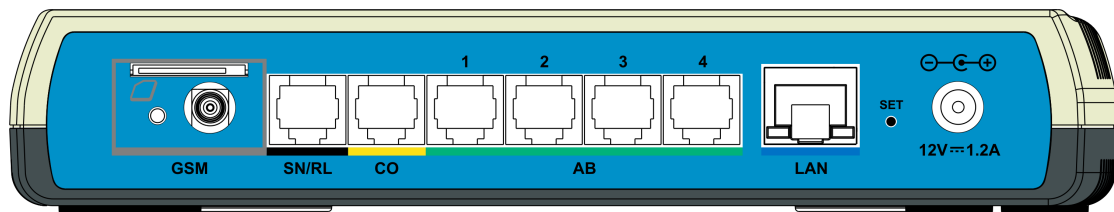

Figure 3.2.2.: Available IPS-08.101 server ports

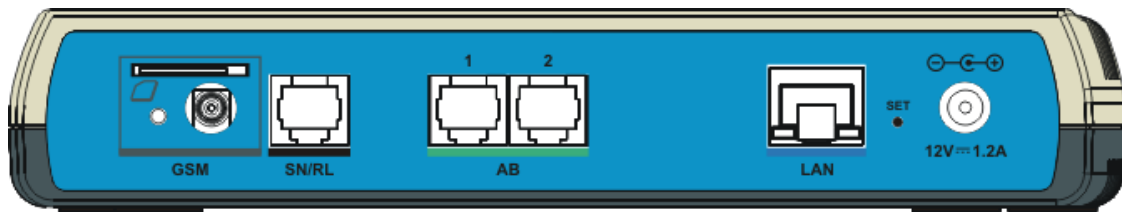

Figure 3.2.3.: Available IPS-08.104 server ports

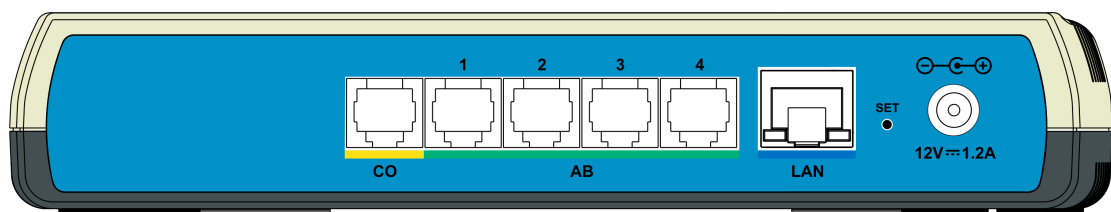
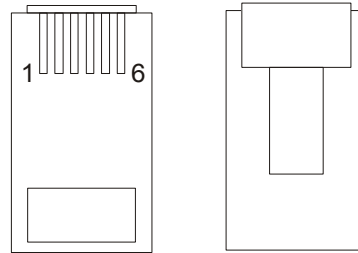

Figure 3.2.4.: Available IPS-08.105 server ports

Cable cords finished with RJ-11 should be installed in accordance with the following table.

3.3 AB, CO ports (RJ-11 connector)

PIN	FUNCTION
1	
2	
3	Line
4	Line
5	
6	



3.4 SN/RL port sensor/relay (RJ-11 connector)

PIN	FUNCTION
1	RL
2	SN
3	
4	
5	SN
6	RL

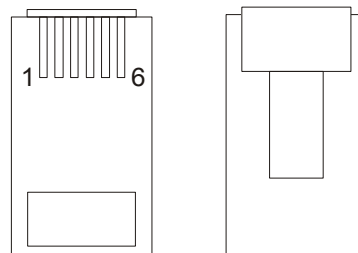

3.4.1 SNS sensor port work modes:

- port can be set in two modes NO (Normal Open) and NC (Normal Connected), mode to choose in server managing application (ConfigMAN),
- server triggering occurs by closing the contact.

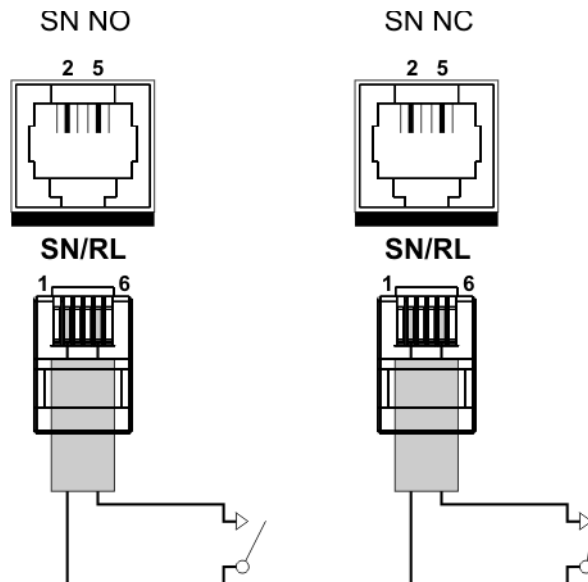

3.4.2 REL relay port work modes:

- port modes can be set to NO (Normal Open) or NC (Normal Connected) and bistable and monostable mode, mode setting is selected in the server configuration application,
- relay parameters: **24V/100mA**

Caution! There cannot be a direct connection and control devices powered from 230V. If needed use a proper relay / contactor.

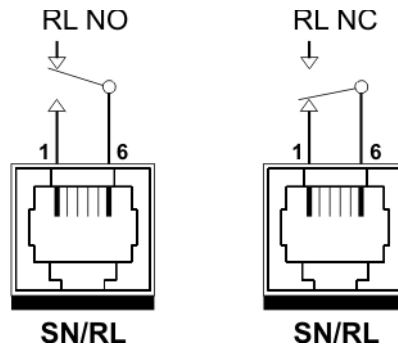

3.5 GSM port (SMA connector)

GSM port operation requires the installation of an external antenna and SIM card.

We offer aerials with 3m cable and SMA plug.

The SMA type plug on the aerial cable should be installed carefully by hand, without the use of tools, as over tightening may damage the connection. Make sure that the aerial is connected and disconnected while the server is turned off, due to an electrostatic charge. When laying out aerials pay attention not to place them in locations too close to electrical or electronic devices (installations) as they might disturb the operation of a GSM module.



3.6 LAN port(RJ-45 connector)

LAN port is used to connect server to a LAN to implement VoIP calls and application server configuration by ConfigMAN.

Simple Ethernet cable compliant with EIA / TIA T568A

PIN	FUNCTION	Color	Color	PIN
1	TX (transmitting pair)	Green/White	Green/White	1
2	TX- (transmitting pair)	Green	Green	2
3	RX+ (receiving pair)	Orange/White	Orange/White	3
4		Blue	Blue	4
5		Blue/White	Blue/White	5
6	RX- (receiving pair)	Orange	Orange	6
7		Brown/White	Brown/White	7
8		Brown	Brown	8

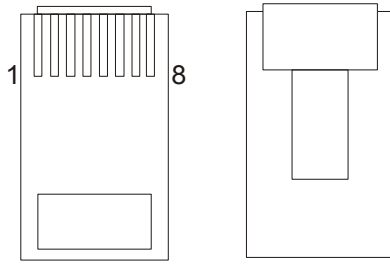

Simple Ethernet cable compliant with EIA / TIA T568B

PIN	FUNCTION	Color	Color	PIN
1	TX+ (transmitting pair)	Orange/White	Orange/White	1
2	TX- (transmitting pair)	Orange	Orange	2
3	RX+ (receiving pair)	Green/White	Green/White	3
4		Blue	Blue	4
5		Blue/White	Blue/White	5
6	RX- (receiving pair)	Green	Green	6
7		Brown/White	Brown/White	7
8		Brown	Brown	8

CAUTION!

The LAN port has auto MDI / MDIX, which automatically recognizes, whether the network cable is a "straight" or "cross-over" (interlace). Therefore, it is also possible to use a crossover cable to connect the PBX to the LAN.

3.7 SET button

Pressing the "SET" button (requires a paperclip or pen) for 3 seconds will switch the configuration server's IP address to the address of 192.168.0.248 (until next power-off), in addition, for three minutes DHCP server is enabled with address pool of 192.168.0.249.

With this solution, even if the computer is plugged directly into the server and it has no constant network settings enabled, it will connect to the server. This mode is confirmed by flashing all the indicator lights on the unit.

3.8 Power connector

Connect the plug of the supplied external power supply into the 12V/1.2A power socket.

CAUTION!

Connecting other type of power supply may result in risk of electric shock. It can also cause acoustic noise (audible hum).

3.9 Description of LED's on the front panel

The following table shows the behavior of the indicator lights on the cover, depending on the mode the server.

Behavior of LED	POWER color		VoIP channel status	LINES public line status	PHONES subscriber status
	<i>red</i>	<i>blue</i>			
blinks fast	system initialization	system initialization	defined at least one VoIP trunk, but none is logged on to the operator	-	-
blinks slowly	-	non-critical error	at least one of the defined trunks properly logged onto VoIP operator	calling from public line	-
stays lit	glow interruption every 4s, normal operation			public line is busy	at least one internal line is busy (conversation or number selection)
is not lit	-	normal operation	not defined any VoIP trunk	public line is available	all internal lines are free

4 microSD card mounting

To, for example, install a microSD memory card or replace 3V battery (type 2032), open the server chassis, this procedure is presented in the following figures:

1. Remove the two screws indicated on the bottom of the housing.

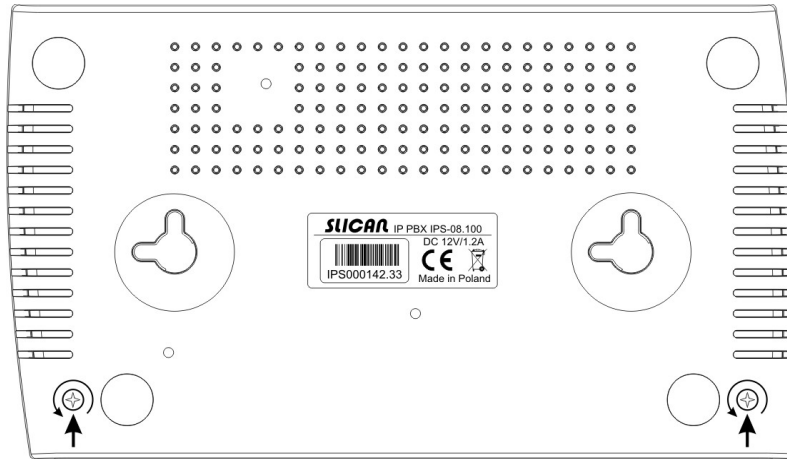

2. Lift the upper part of the housing.

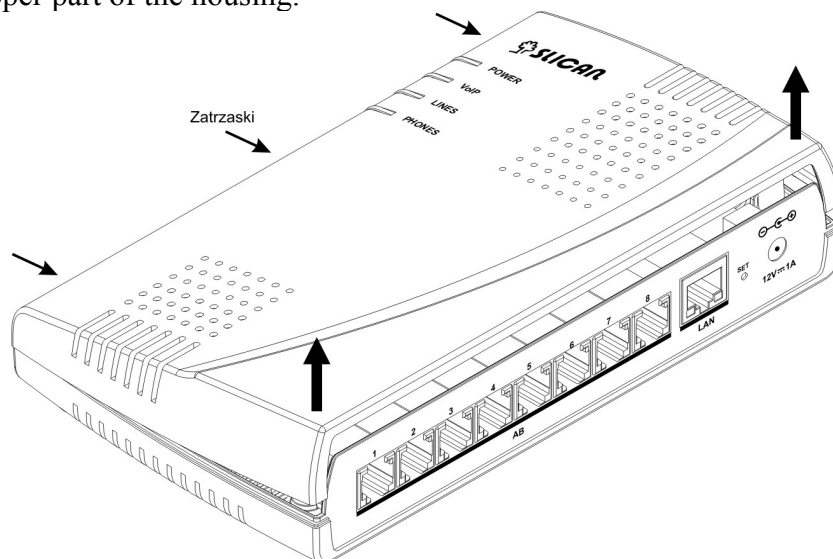

3. Sample view of the PCB board in the IPS-08 server.

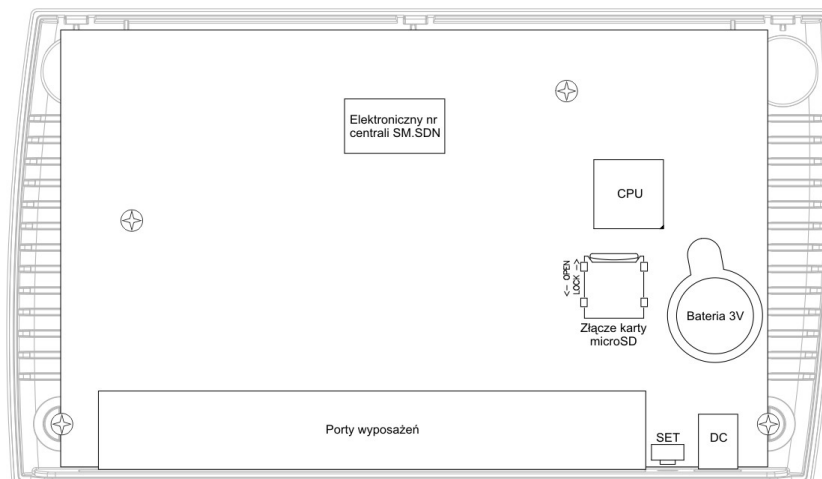

Note: there is a danger of explosion if battery is replaced by an incorrect type. Dispose the batteries according to local regulations.

5 Security requirements for operating IPS-08 servers

It is essential to comply with the rules governing safety and use to ensure correct operation of this device. Below are the basic elements to be taken into account by the manufacturer in the case of any complaints and claims submitted by the users. The rules relate to the installation, location of the server and the requirements for the electrical power supply and data communication network.

5.1 Instalation requirements

- Only authorised or qualified manufacturer's service teams are allowed to install and initialise the device.
- All the installation procedures should be performed in compliance with the assembly principles as well as any occupational health and safety regulations.
- Due to the heat dissipation it is recommended that the device is installed in a vertical position so that the output was available on the right.

5.2 Workplace Environment

1. The device should not be installed in enclosed areas with high humidity due to the durability and performance of electronic components.
2. Due to the risk of flooding, the device should not be placed near bodies of water or sources of streams (eg swimming pools, water taps).
3. The device should not be placed in areas with strong dust or in areas with a high intensity electromagnetic field.

Due to the possibility of malfunction, noise, or discoloration of the surface is not recommended to install the system:

- areas with direct sunlight,
- locations where vibration and shock are particularly frequent or severe,
- near the radio antenna.

All devices connected to the device should have a certificate of conformity with the standards in force in the European Union.

6 Certificate of Conformity and Correct Product Disposal

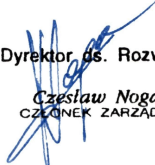
Certificate of Conformity		
Manufacturer: SLICAN sp. z o.o. ul. M. Konopnickiej 18 85-124 Bydgoszcz	Type: Telecommunication server	Model: Slican IPS-08.100; Slican IPS-08.101; Slican IPS-08.103
Product description: IPS-08.100 server with capacity of 8 AB ports and VoIP, IPS-08.101 server with capacity 4AB, 1CO, 1GSM, 1RL1SN ports and VoIP and IPS-08.103 server with capacity 4AB, 1CO ports and VoIP. Servers can be expanded with 4 to 8 analogue phones oor general usage with pulse and tone dialing VoIP phones. Server cooperate with public network through analog trunks with ASS, GSM signalling VoIP operator through LAN interface.		
The product complies with Directive No. 99/5/EC R&TTE and meets the requirements specified in the harmonised standards mentioned in harmonised standards:PN-EN 60950-1:2007 + A12:2011; PN-EN 55022:2011; PN-EN 55024:2011		
Additional Information: The updated content of Certificate of Conformity is available on our web page at www.slican.pl/deklaracje/ The device also fulfils the requirements regarding the allowed levels of interference for class B devices.		
Bydgoszcz 10-09-2013	Dyrektor ds. Rozwoju  Czesław Noga CZŁONEK ZARZĄDU	

Product Disposal (old electric and electronic equipment)

If you find this symbol on the product or in relevant documents, it will mean that once the service life is over the product must not be removed in the same way as other household or industrial waste materials. Uncontrolled disposal of this product may cause harm to the natural environment or human health. Carefully separate this product from other wastes and make it recyclable in order to promote the idea of a conscious and standard policy of using resources. Further information on the place and method of safe environmental disposal of this product is available from retail dealers or local governmental agencies. Corporate users should contact the supplier and review the contracts. The product must not be mixed with other municipal waste materials.