

IP Phone

VPS-802

Instruction Manual

Release 1.00

Date of last modification: 16.02.2015



Table of Contents:

<u>1. IP Phone VPS-802</u>	<u>5</u>
<u>1.1. Notice Information</u>	<u>5</u>
<u>1.1. Packing List.....</u>	<u>6</u>
<u>2. Phone Installation</u>	<u>8</u>
<u>2.1. Attach the foot stand</u>	<u>8</u>
<u>2.2. Connect the Handset and optional Headset.....</u>	<u>8</u>
<u>2.3. Connect the Network and Power</u>	<u>8</u>
<u>2.4. Initialization</u>	<u>8</u>
<u>3. Getting Familiar with Your Phone</u>	<u>11</u>
<u>3.1. Hardware Components Preview</u>	<u>11</u>
<u>3.2. Icon Preview</u>	<u>14</u>
<u>4. Phone Configuration</u>	<u>15</u>
<u>4.1. Basic Features Configuration</u>	<u>15</u>
<u>4.2. Web Login</u>	<u>15</u>
<u>4.3. Administrator Password</u>	<u>16</u>
<u>4.4. Language.....</u>	<u>17</u>
<u>4.5. Time and Date</u>	<u>17</u>
<u>4.6. Screen Saver</u>	<u>19</u>
<u>4.7. Ring Tone</u>	<u>20</u>
<u>4.8. Volume</u>	<u>21</u>
<u>4.9. Directory – edit contact list</u>	<u>22</u>
<u>4.10. Call history</u>	<u>24</u>
<u>4.11. Network configuration.....</u>	<u>24</u>
<u>5. Configuration VoIP account.....</u>	<u>25</u>
<u>5.1. Basic configuration VoIP account</u>	<u>25</u>

5.2. Advanced configuration VoIP account.....	26
6. Basic Call Features.....	26
6.1. Place a Call	26
6.2. End a Call	27
6.3. Receive a Call	27
6.4. Auto answer.....	28
6.5. Call Hold	28
6.6. Call Transfer	29
6.7. Call Conference	30
6.8. Call Forward	31
6.9. Call Return (REDIAL).....	33
6.10. Anonymous Call.....	34
6.11. Call Mute.....	34
6.12. DND (Do Not Disturb)	34
6.13. Key as Send	35
6.14. No Key Entry Timeout	35
6.15. Hot Line	35
7. Advanced Features.....	36
7.1. Voice Message.....	36
7.2. Intercom	37
7.3. Speed Dial	38
7.4. Direct Pickup	38
7.5. Group Pickup.....	38
7.6. BLF(Busy Lamp Field).....	39
7.7. Shared Line.....	40
7.8. Call Park	41

7.9. Paging.....	41
7.10. DTMF	42
7.11. Prefix	42
7.12. Action URL.....	43
7.13. Keybord Layout	43
7.14. Keypad Lock	43
8. Management and Upgrade	44
8.1. Start	44
8.2. Factory Reset	44
8.3. Software update.....	45
8.4. Remote Phonebook.....	46
8.5. System Log	47
8.6. TLS Certyficates	47
9. Troubleshooting	48
9.1. Why is the phone LCD screen blank?.....	48
9.2. Why does the phone display "Network Unavailable"?	48
9.3. Why can't I get a dial tone?	48
10. Annex	49
10.1. Technical Specification	49
10.2. Voice Parameters	49
10.3. Network Parameters	49

1. IP Phone VPS-802

Thank you for purchasing the VPS-802. It is a fully functional mobile web enables voice communication over the network. This device works like a traditional phone: You can make and receive calls and use other functions specific to a regular phone.

This phone has other features data services that are unavailable in traditional phones.

This manual contains information on the features and services available on the device.

1.1. Notice Information

Before you connect and start using your phone, please read the following information.

They are important, the unit will operate in a safe and reliable.

Safety cautions

1. To use the power adapter that delivered with the phone. Other power adapters may damage the phone.
2. The phone is only for indoor use. And also avoid in high humidity, water and some other liquids.
3. Do not use the phone during thunderstorms.

Disposal of the phone



This symbol indicates that the product is classified as electrical or electronic equipment and should not be disposed of with other commercial or household waste at the end of its working life.

Cleaning

To clean the device, use an anti-static cloth. Please avoid cleaning liquids as they might damage the surface or internal electronics of the phone.

„The manufacturer reserves the right to make changes to the product without prior notice.”

www.slican.pl

e-mail: office@slican.pl

1.2 Packing List

The package contains the following parts, please check if all the items are not missed:

PHONE

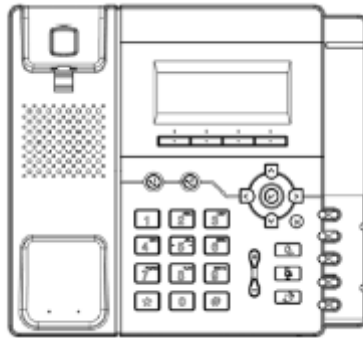

THE FOOTSTAND

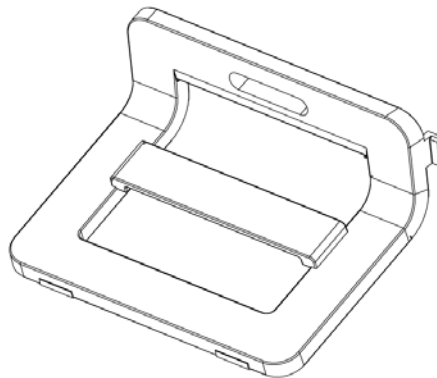

HANDSET



HANDSET CORD

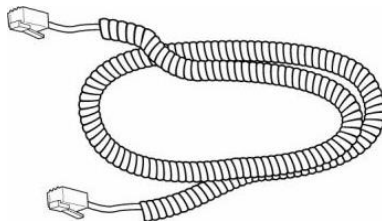

POWER ADAPTER

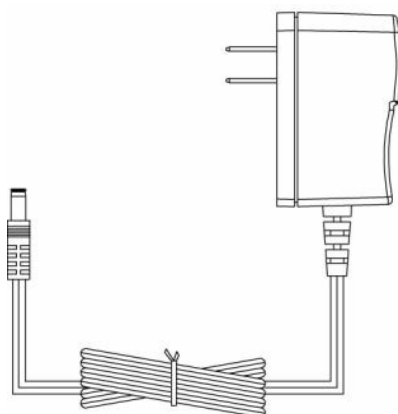

ETHERNET CABLE

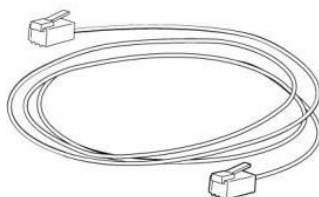

QUICK INSTALLATION REFERENCE



2. Phone Installation

2.1. Attach the Foot stand

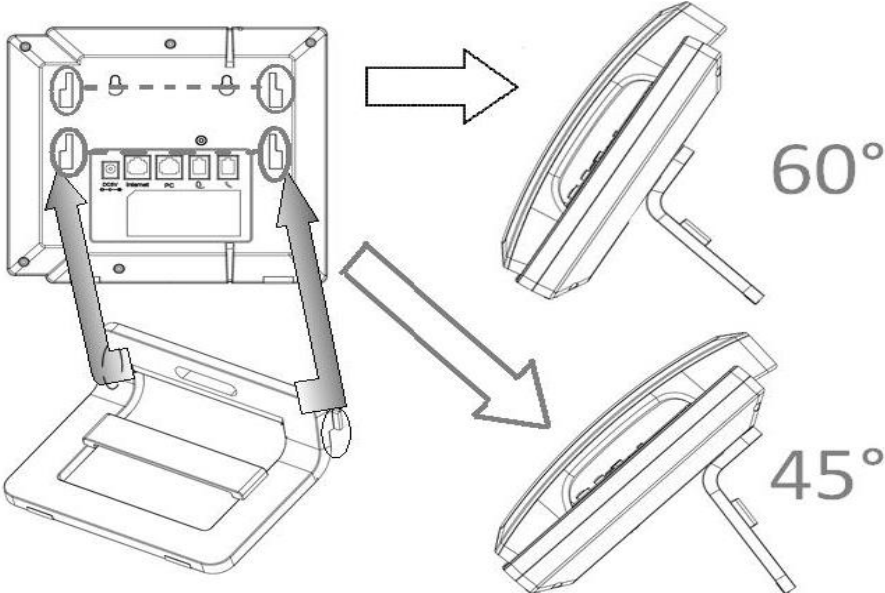

2.2. Connect the Handset and optional Headset.

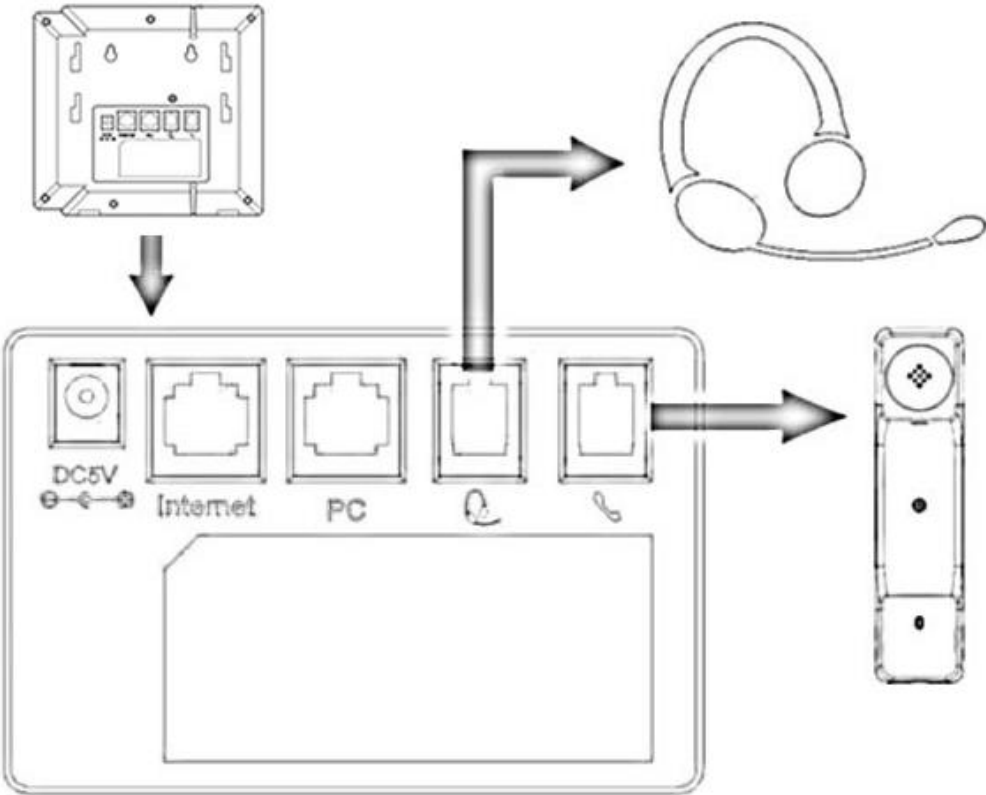

2.3. Connect the Network and Power

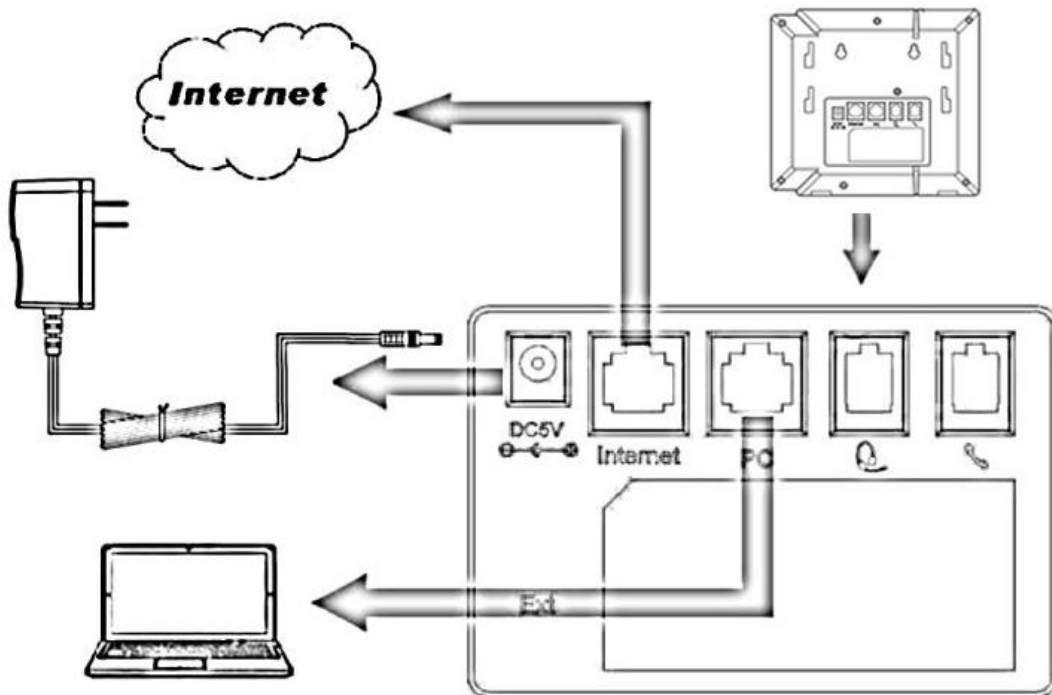

2.4. Initialization

After your phone has been powered up, the system boots up and performs the following steps:

- automatic phone initialization

The phone finishes the initialization process by loading the saved configuration. The phone LCD screen will display "Booting":

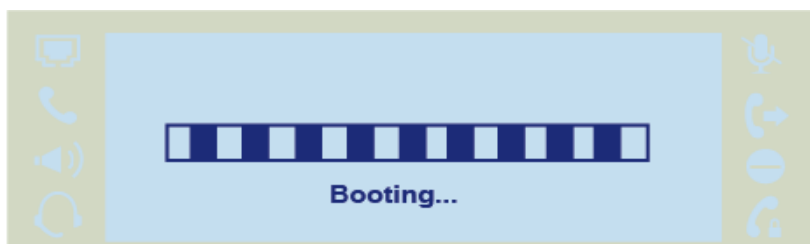

- and then show "Initializing" during the initialization process.







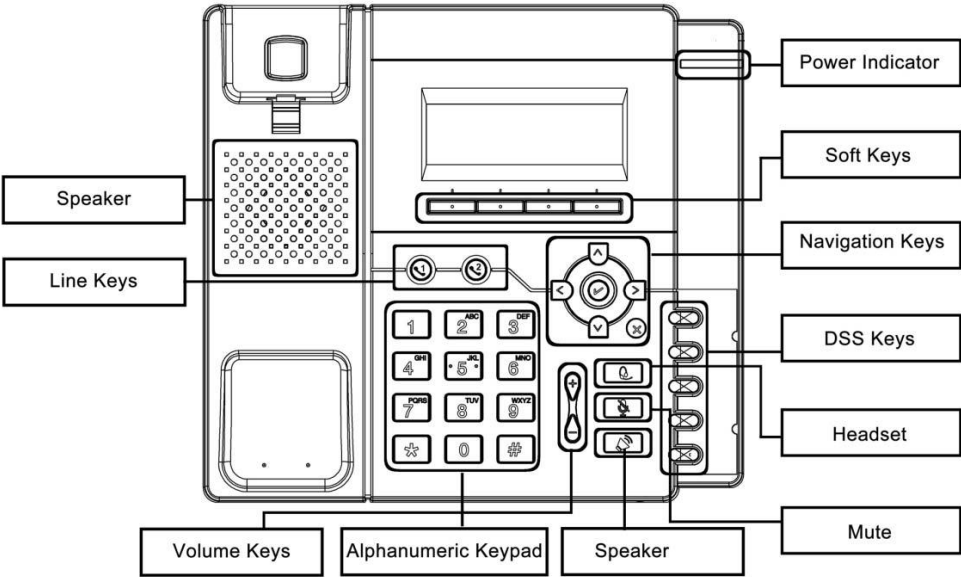

By default the phone attempts to contact a DHCP server in your network in order to obtain its valid network settings, e.g. IP address, subnet mask, default gateway, DNS server.





3. Getting Familiar with Your Phone

3.1. Hardware Components Preview

















Element	Opis
LCD screen	To Presentation all information about the date& time, accounts, soft keys, messages, calls and other some information.
Power Indicator LED	To indicate the power status
Line keys	The phone supported up to 2 accounts Steady green: idle interface, during a call. Blink red: a call incoming
Soft keys	Labels automatically to identity their context-sensitive features.
Navigation keys	 OK  Up arrow key: to move up of the selection shows on the screen.  Right arrow key: to move right of the selection shows on the screen.

	 Left arrow key: To move left of the selection shows on the screen.  Down arrow key: To move down of the selection shows on the screen.  1. To return to idle screen. 2. To cancel the information or call on the screen.
Mute key	 Mute the voice during the call (green light).
Memory Keys	<p>To be configured as different function as:</p> <ol style="list-style-type: none"> 1. Line 2. Speed Dial 3. BLF 4. BLF List 5. Voice mail 6. Direct Pickup 7. Group Pickup 8. Call Park 9. Intercom 10. DTMF 11. Prefix 12. Hold 13. Conference 14. DND 15. Redial 16. Transfer 17. SMS 18. Hot -desking 19. Call Return 20. Paging 21. Record 22. Shared Line <p>The LED lights status when set as Shared line:</p> <ol style="list-style-type: none"> 1. Stay green: Idle 2. Stay red: Busy 3. Blinked green: Ring Back 4. Blinked red: A call incoming 5. Steady orange: During a call 6. Blinked orange: Public Hold 7. Blinked green: Private Hold 8. Light Drown: Unregistered

Speaker	 Press this button to place a call in hands-free mode.
Volume	 To decrease the volume.  To increase the volume.
Alphanumeric keypad	To enter the phone numbers, letters and so on.
Message	 To indicator the New message, and press to read.
Zestaw słuchawkowy	 To indicate that the phone is or not in Headset mode.

3.2. Icon preview

Icon	Description
	Network
	Registered succeed
	Unregistered
	Speakerphone mode
	Handset mode
	Headset mode
	Mute
	Forward
	Do Not Disturb
	
	Received calls
	Dialed Calls
	Missed calls
	Forward calls

4. Phone Configuration

4.1. Basic Features Configuration

This part will mainly introduce the basic configuration as the Time, Language, and Volume by the help of the LCD display.



Advanced features require knowing the password for configuration (default: admin)

4.2. Web Login

Get the IP address: Press Menu → Status → Information (phone defaulted as a DHCP client)

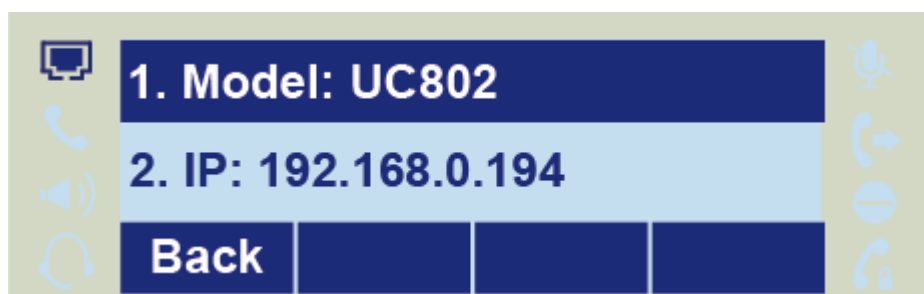

Input the IP Address in the web browser.

Wprowadź nazwę swojego użytkownika (domyślnie **admin**) oraz hasło (domyślnie **admin**).

Login successfully.

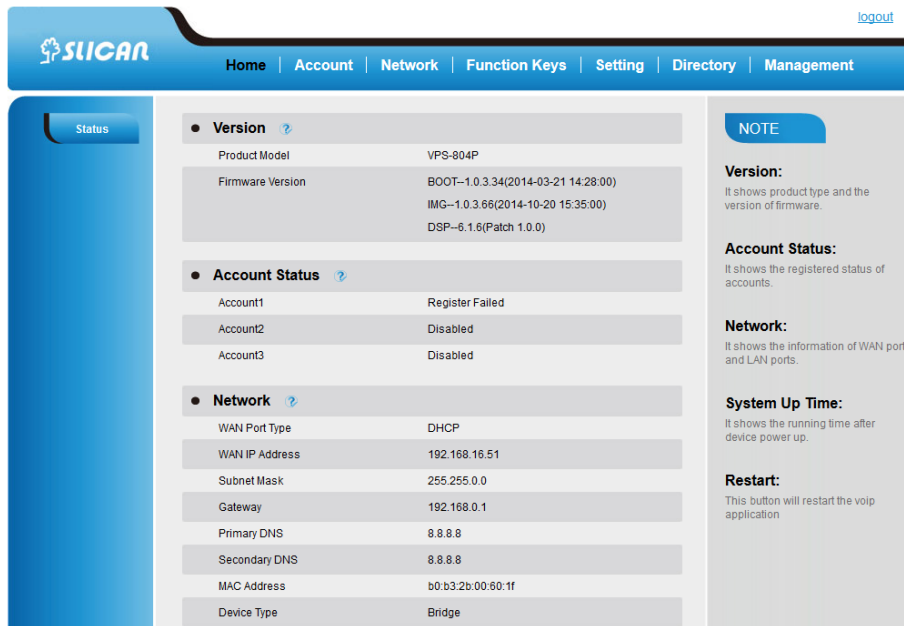

4.3. Administrator Password

The password is mainly used for login the web interface or set the advanced settings through phone interface. And the default password of the administrator is: **admin**

To change to password via Phone Interface

Press *Menu* → *Setting* → *Advanced settings* → *password(default admin)* → *Phone Setting* → *Set Password*
Enter the current PWD (password), new password and confirm the new password.

Press save soft key or  to save the new password.

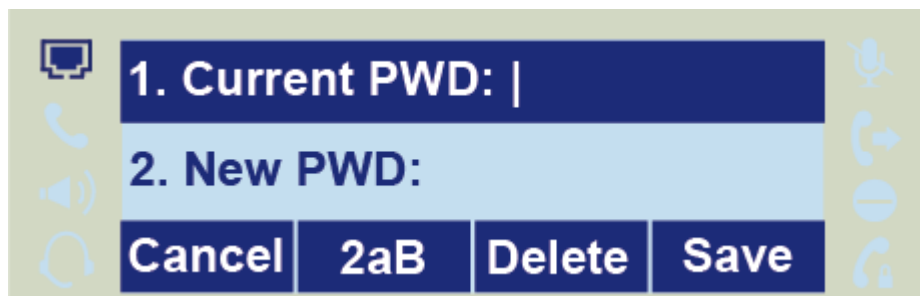

To change to password via Web Interface

Management → *Password*

Fill the value: *Current password*, *new password*, *confirm the password* then click *Save* to save the configuration.

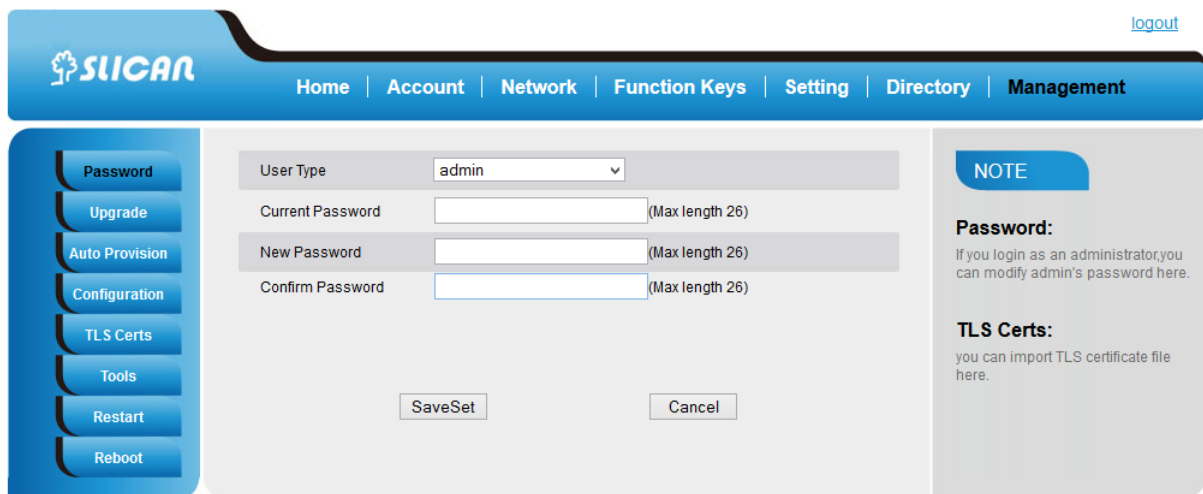

4.4. Language

The default Phone interface language is English (both LCD Menu and WEB interface).

To change the language via Phone interface

Press: *Menu* → *Settings* → *Basic Settings* → *Language*.

Press: *Save* soft key to save the configuration.



To change the language via Web Interface

Select: *Setting* → *Preference* → *Web Language*

Select the necessary one.

Press : *Save*, to save the configuration.

Note:

Note:



All languages may not be available for selection. The available languages depend on the language packs currently loaded to the IP phone.

4.5. Time and Date

The time and date show on the idle page, and it can be set and change by SNTP server automatically or manual setting.

To configure the time and Date by SNTP setting

Press: *Menu* → *Setting* → *Basic setting* → *Time & Date* → *SNTP Settings*

Press  or , or info soft key to change the Time zone.

- NTP server

Fill the NTP server1, NTP Server2 (default: tempus1.gum.gov.pl).

- Daylight Saving.



The choice: Auto, Daylight Saving Time on and off.

Press  or Save soft key to save the configuration.



To configure time and date manually



To press : *Menu* → *Setting* → *Basic setting* → *Time & Date* → *Manual Settings*



Press  and  or change the right time, or you can input the right time.

Press  or Save soft key to save the configuration.

To configure the Time & Date Format

To press: *Menu* → *Setting* → *Basic setting* → *Time & Date Format*



Press  and  or press Info to change between 12 Hour or 24 Hour.

Press  and  or press Info to change among Y-M-D(year-month-day), M-D-Y(month-day-year), D-M-Y(day-month-year).

Press  or Save soft key to save the configuration.

To configure the DHCP time

To press: *Menu* → *Setting* → *Basic setting* → *DHCP time*

Press  and  or press Info to change between Disable and Enable.

Press  or Save soft key to save the configuration.

To configure the Time and Date by web interface

Select: *Network* → *Advanced* → *NTP Server*

Set IP address NTP server (default: tempus1.gum.gov.pl).

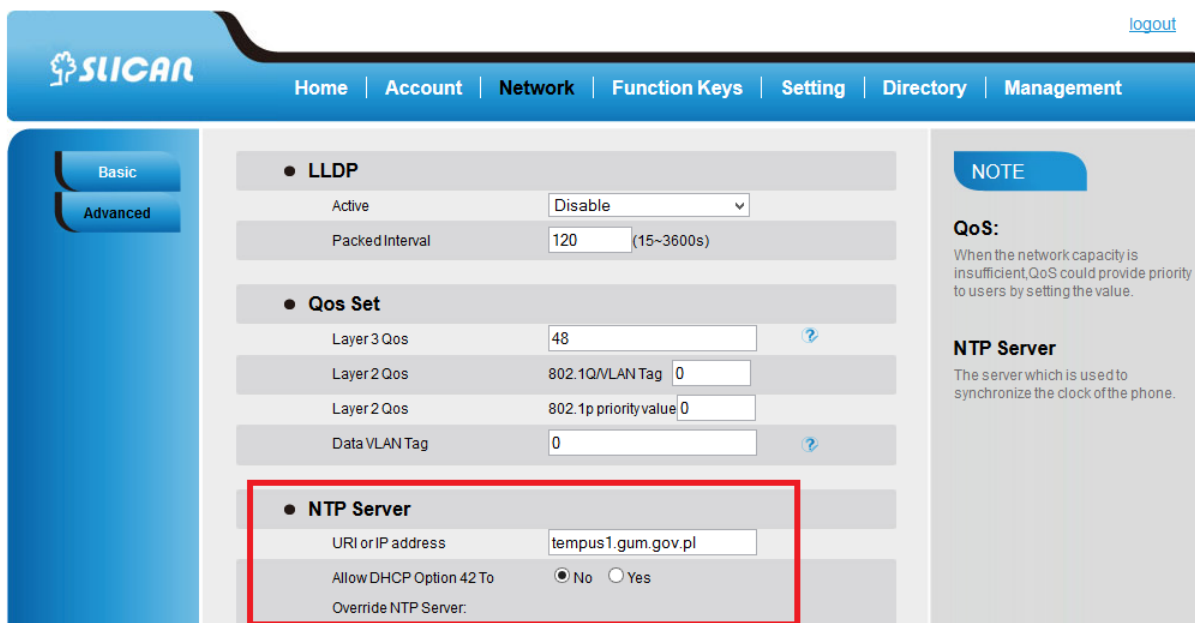

To change the Time Zone and Date Display Format via web interface

Select: *Setting* → *Preference* → *Time Zone*

Select the necessary one. Press *Save* to save the configuration.

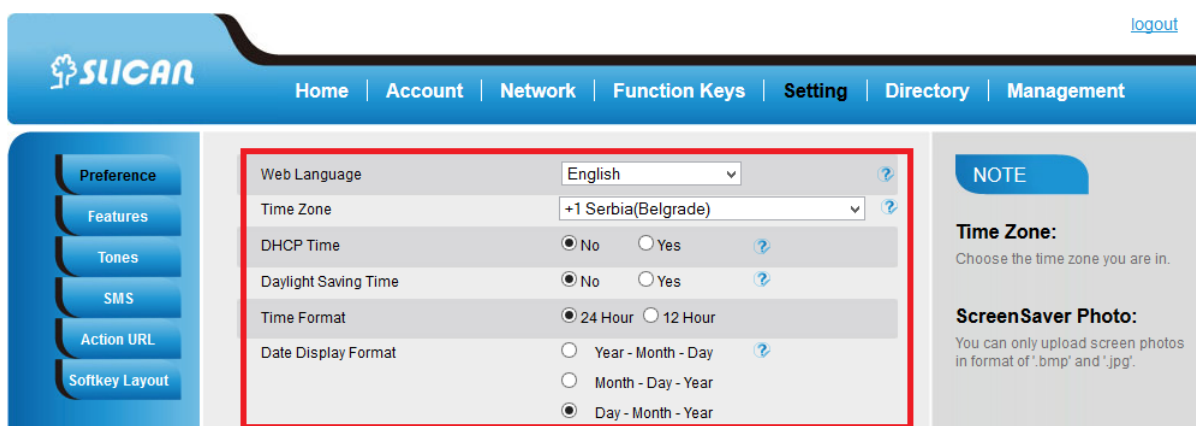

Note:



If the IP Phone cannot obtain the time and date from the Simple Network Time Protocol (SNTP) server, please contact your system administrator for more information.

4.6. Screen Saver

There are two types of screen saver: Backlight off, Time & Logo .

To enable screen saver via Phone



To press: *Menu* → *Display* → *Screensaver...*

Press  and  or press Switch soft key to Choose the Time-out as 1 min or 2/5/10/30 minute.
Enter the Screensaver Type to choose one of the type: Backlight off, Time & Logo.

Press  or Save soft key to save the selected configuration.

To disable screen saver via Phone

To press: *Menu* → *Display* → *Screensaver...*

Press  and  or press Switch soft key to Choose the Time-out as off.

Press  or Save soft key to save the selected configuration.

To Enable screen saver via Webpage

Select: *Setting* → *Preference*

To choose the Time-out as 1 min or 2/5/10/30 minute.

To select the screen Type as Backlight off or Time & Logo.

Click Saveset to save the configuration.

To Disable screen saver via Webpage

Select: *Setting* → *Preference*

To choose the Time-out as Off



Click Saveset to save the configuration.

4.7. Ring Tone

You can adjust the type and volume of the ring tone.

Change the ringing tone via phone interface

To press : *Press Menu* → *Setting* → *Basic Settings* → *Ring Tone*.

Press  and  to select the aimed one.

Press  or *Save* soft key to save the configuration.

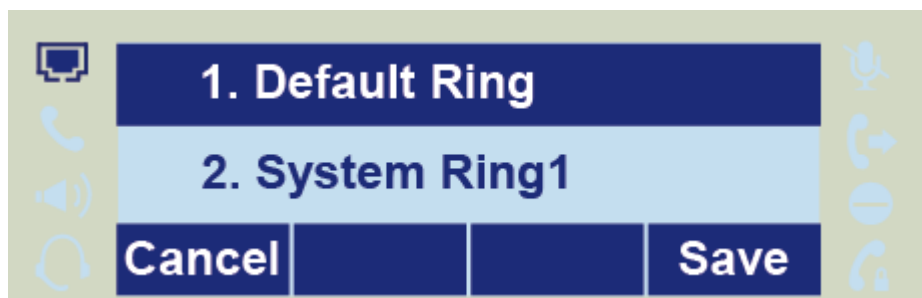

Change the ringing tone via WEB interface

Selekt: *Account* → *Advanced* → *Account Ring Tone*

Make Your choice

Click to *Saveset* to save the configuration..

[logout](#)

SICAR Home | Account | Network | Function Keys | **Setting** | Directory | Management

Preference
Features
Tones
SMS
Action URL
Softkey Layout

Web Language	English	?
Time Zone	+1 Serbia(Belgrade)	?
DHCP Time	<input checked="" type="radio"/> No <input type="radio"/> Yes	?
Daylight Saving Time	<input checked="" type="radio"/> No <input type="radio"/> Yes	?
Time Format	<input checked="" type="radio"/> 24 Hour <input type="radio"/> 12 Hour	
Date Display Format	<input type="radio"/> Year - Month - Day <input type="radio"/> Month - Day - Year <input checked="" type="radio"/> Day - Month - Year	?
Keypad DTMF Tone	<input checked="" type="radio"/> On <input type="radio"/> Off	?
MIC Volume Amplification	0dB default	
Backlight Time	0	?
Screen Time Out	off	
Text Logo		?
ScreenSaver Type	time & logo	
Ring Tones	Ring2.bin	
NO Key Entry Timeout(seconds)	0	?
Dial-now Time-out (seconds)	0	?



NOTE
Time Zone:
Choose the time zone you are in.
ScreenSaver Photo:
You can only upload screen photos in format of '.bmp' and '.jpg'.

Assign a ring tone to a contact on your phone

Press *Directory*.



Select the target contact.

Press Detail soft key to edit the contact.



Press  and  to select the wanted Ring Tone for the contact

Press *Save* soft key to save the contact.



4.8. Volume

You can adjust the volume for the phone by the volume keys:  and .

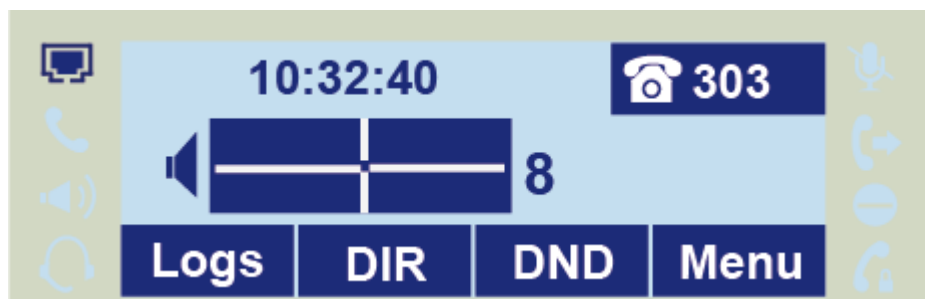

To adjust the Ring tone volume

Option 1: To press  and  on the idle page





Option 2: To press  and  during the call is ringing.

To adjust the handset volume

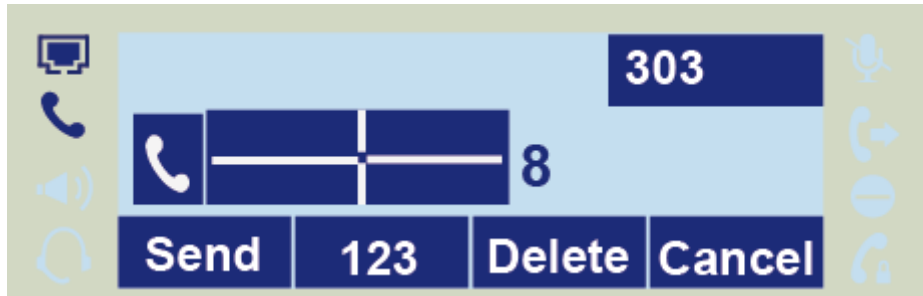

To press  and  during a call in handset mode.

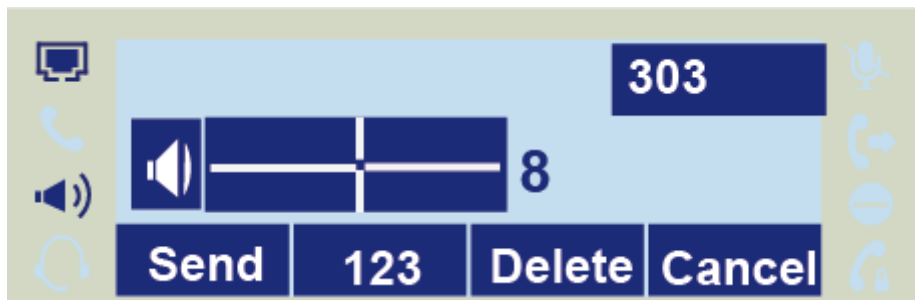

To press  and  during a call in speaker mode.



To adjust the headset volume

To press  and  during a call in headset mode.

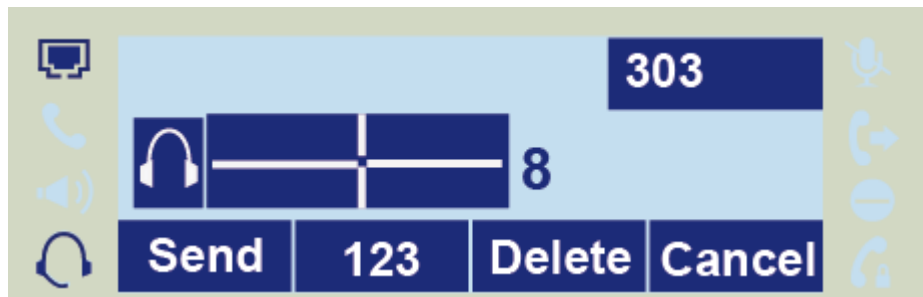

4.9. Directory – edit contact list

In the directory, you can add or delete your friends, business partner or anyone others' phone No. so you will not forget their number. Or put some anonymous phone No. in the blacklist to prevent from being disturbed.

To add contacts manually

Press: *Menu* → *DIR*

Press: *Add* soft key

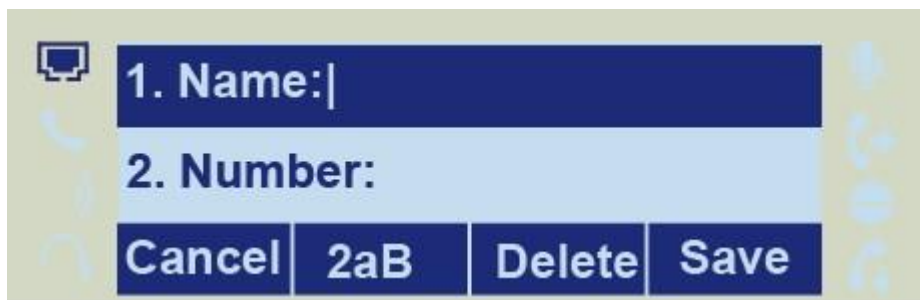

Enter the necessary information as Name, Phone number...

Press save soft key or  to add the contacts successfully.

To add contacts from Call Log

Press: History soft key or press *Menu* → *Logs* → *Local history*

Press  and  to select the targeted one. (Press  and  switched among the All calls, Dialed calls, Received calls, Missed Calls and Forward Calls).

Edit the necessary information as Name, Phone number...

Press save soft key or  to add the contacts successfully.

To add contacts via WEB interface

Click Directory.

Enter the name, number and some other information.

Press *Add* and next *Save* button.

To add blacklist manually

Press: *Menu* → *Directory* → *Blacklist*

Enter the necessary information as Name, Phone number...

Press save soft key or  to add the contacts successfully.

4.10. Call Log

Displays the call history broken down into: received, missed, dialed numbers and forwarded.

From your phone, press : *History*.

Icon in the record indicates to us the type of call: incoming, outgoing, etc.

From WEB interface select: *Directory*→*Call log*→*Dialed numbers, Received*

4.11. Network Configuration

The phone is configured as a DHCP client and after connect to network automatically get the IP address assigned by a DHCP server.

To check IP address from phone interface press: *Menu*→*Status*→*Information*

In the absence of a DHCP server, you must configure a static IP address, subnet mask, gateway, and DNS server. After the above information, please contact the network administrator.

From phone LCD menu:

Press: *Menu*→*Settings*→*Advanced*→*Network*→*WAN Port*→*Static mode*.

From WEB interface:

Select: *Network*→*Basic*→*Static address*.

You can also get the IP address logging phone to the network using PPPoE protocol.

In this case, enter your account name (login) and password you received from your network administrator.

From phone LCD menu:

Press: *Menu*→*Settings*→*Advanced*→*Network*→*WAN Port*→*PPPoE mode*.

From WEB interface:

Select: *Network*→*Basic*→*PPPoE*.

5. Configuration VoIP Account

For the realization of voice calls, it is necessary to configure the SIP accounts. After all the data for account setup, ask your network administrator or service provider VoIP.

To properly configure the SIP account as follows:

- set VoIP server address
- backup SIP server (optional)
- username (User ID)
- register name (Authenticate ID)
- password
- account name (on LCD display)

The screenshot shows the SICAR web interface for configuring a VoIP account. The page is titled "Account" and shows a dropdown menu for "Account 1". The account status is "Register Failed". A red box highlights the configuration fields: Account Active (Yes), Primary SIP Server (10.0.0.60), Failover SIP Server, Second Failover SIP Server, Prefer Primary SIP Server (No), Outbound Proxy, Backup Outbound Proxy, SIP Transport (UDP), NAT Traversal (No, but send keep alive), Label (342), SIP User ID (620), Authenticate ID (620), Authenticate Password (masked), and Name.

5.1. Basic Configuration VoIP Account

Basic configuration VoIP account requires knowledge of VoIP account login details, such as: SIP server address, user name, service, service user password.

From LCD menu:

Press: Menu→Settings→Advanced→Account.

Fill SIP server name, username, password, register name.

From WEB interface:

Select: Account→Basic

Fill SIP server name, username, password, register name.

Note:

After data for your VoIP account login, please contact your service provider or network administrator.

5.2. Advanced Configuration VoIP Account

From the web interface you can configure advanced settings for SIP account:

Outband proxy: Proxy SIP sever address provided that the VoIP service requires its settings.

Active account: enable/disable the account registration.

SIP Transport: type of transport protocol - UDP(default), TCP, TLS.

Type DNS: DNS Server search service.

Empire of registration: expiration time of registration to the SIP server, if the register expire time of the phone is different from the time required by the server, it will automatically changed for the time recommended by the server and register again.

Outgoing call without registering:: permit or prohibit making calls without registration to the SIP server.

Local SIP port: port for VoIP call signaling process - the default 5060.

Local RTP port: port for used to transfer audio frames - 5004 by default.

Codecs: settings for compression codecs in order to use of acoustic signals negotiated in the call signaling.

DTMF mode: specifies how to send DTMF

- DTMF in the band
- DTMF SIP INFO
- DTMF RFC 2833

SRTP mode: activation of RTP voice encryption frames.

VAD(Voice Activity Detection): detection of silence during a call.

Ringtone for an account: assign one of 8 ringtones for your account.

Ring time: phone ringing time settings for incoming calls.

Sign # as a send: use the # key as a sign of the end of the dial.

Subscribe for MWI message: MWI settings for sending messages informing about the new voice message.

Anonymous calls: reservation number for outgoing calls CLIP.

Anonymous Call Rejection: enable anonymous call rejection.

Auto answer: allows to automatically answer incoming calls.

Rejection of the return code: reject code defines a call in the SIP signaling.

Direct interception code: service code interception defined by the administrator of the SIP server.

Interception group code: service code interception in the group defined by the administrator of the SIP server.

NOTE:

These data are dependent on the specific VoIP server settings. Their parameters are set by the service provider or network administrator.

6. Basic Call Features

6.1. Place a Call

There are three ways to dialing a call: Handset, Headset and Hands-free speakerphone.

To place a call by Handset

Pick up the handset, or press a line key and dial the necessary number.

Press  or press the send softkey, then the call is sending.

To place a call by Headset:

Press the  (light is Green),
Enter the desired number.

Press  or press the *Send* softkey, then the call is sending.

Placing a call by hands-free speakerphone

Press the , or press the Line key, then you can hear the dial tone.
Enter the number.

Press  or press the *Send* soft key, then the call is sending.

To place a call by call history or Directory

Press the *History* soft key or *Menu* → *History /Directory*

Press  and  to select the targeted one.

Press  or *Send* soft key to make the call.

NOTE:

The  key is set to be a send key. You can set the * key as send key or set some other to be as send keys. For more information, refer to the Key as Send on page
During the call, you can also change among Headset, Handset or Free-speaker mode.

6.2. End a Call

There are three ways to end a call:

To end a call by Handset

Naciśnij przycisk „Anuluj” lub odłóż słuchawkę.

To end a call under Headset Mode

Press *Cancel* soft key or press .

To end a call under hands-free Speakerphone Mode

Press the *Cancel* soft key or press .

NOTE:

During the conference, to end the call is same as mentioned above.

6.3. Receive a Call

There are three ways to receive a call when the phone is ringing:

To receive a call by handset

Pick up the handset the conversation is built.

str. 27

To receive a call by headset

Press  and now the conversation is built.

To receive a call by hands-free speaker

Option 1: Press  directly.

Option 2: Press Answer soft key.

Option 3: Press the Line key (flashes red).

Moreover, some other action can be done by soft key when the call is coming.

To press the *Reject* soft key to reject the call. Or press  to reject the current call.

To press *Forward* to forward to another phone.

To press *Silence* soft key, and then the call will keep silent, no ring tone display.

6.4. Auto answer

Enable auto answer feature, you will answer all incoming call automatically.

To enable Auto Answer via Webpage

To Click: *Account* → *Advanced*

To choose Yes for the Auto Answer.

To click Saveset to save the configuration.

6.5. Call Hold

When use hold feature, the *Hold* icon will show on the display.

To make a call on hold during three modes:

To hold a call under handset mode:

Press *Hold* soft key to hold the current call.

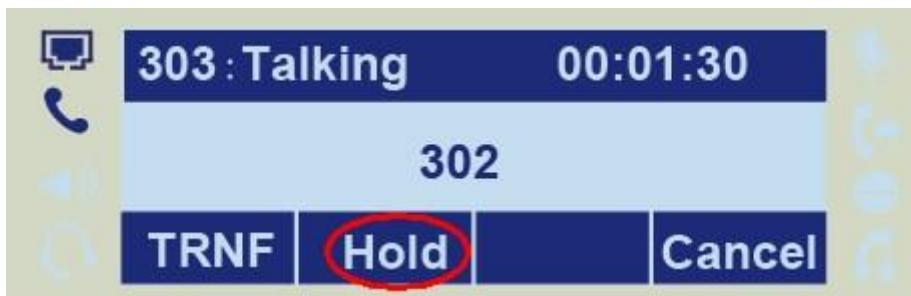

Press *Resume* soft key to resume the call on hold.

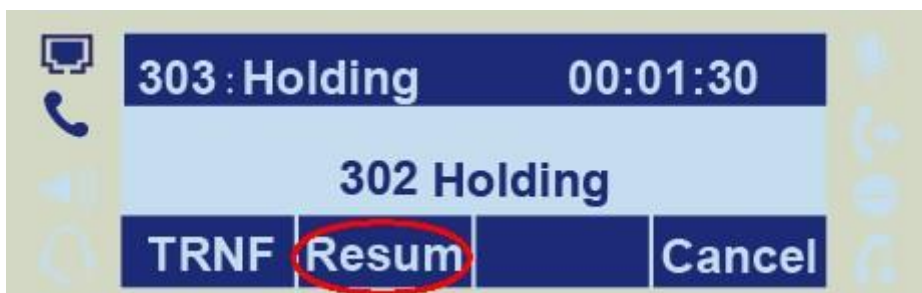

To hold a call under headset mode:

Press Hold soft key to hold the current call.
Press Resume soft key to resume the call on hold.

To hold a call during the speaker mode:

Press *Hold* soft key to hold the current call.
Press Resume soft key to resume the call on hold.

6.6. Call Transfer

This phone supports blind, attended and Semi-Attended Transfer.

Blind Transfer

Press Transfer soft key during the conversation, the call is on hold now.

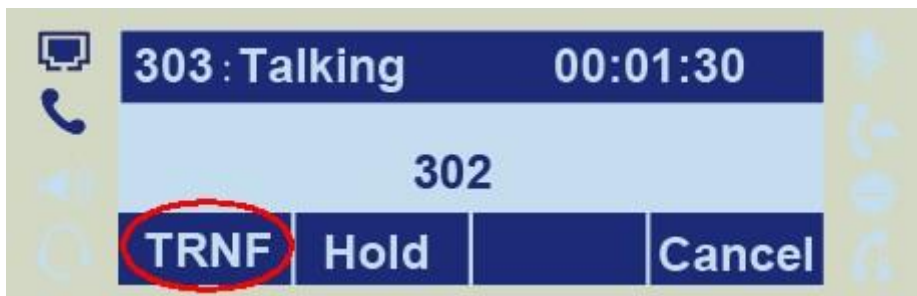

Enter the number that transfers to.

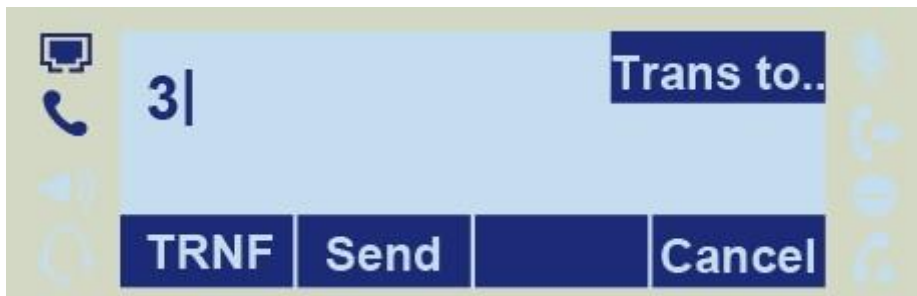

Press *Transfer* soft key , and now the blind transfer completed.

NOTE:

The "Enable Call Feature" must be configured to "Yes" to enable this feature.

Attended Transfer

When you use this feature, you can:

Press transfer soft key during the conversation, the call is on hold now.

Enter the number that transfer to, and press the send soft key or 

Start the second conversation, press the transfer soft key, then, transfer completed.

NOTE:

To transfer calls across SIP domains, SIP service providers must support transfer across SIP domains. Blind transfer will usually use the primary account SIP profile. To use this function, should at least one line key set as Auto.

Semi-Attended Transfer

Press the *Transfer* soft key during the conversation, the call is on hold now.
Enter the number transfer to, and then press , then you can here the ring tone.
Press the *Transfer* soft key, and now the Semi-attended transfer completed.

BLF Transfer

Set a Programmable Key or line key is set as BLF. For how to set BLF, please refer to [BLF](#)
Press the transfer soft key during the conversation, the call is on hold now.
Press: BLF key then realize blind, attended and Semi-Attended Transfer. (Webpage--Setting--Features)

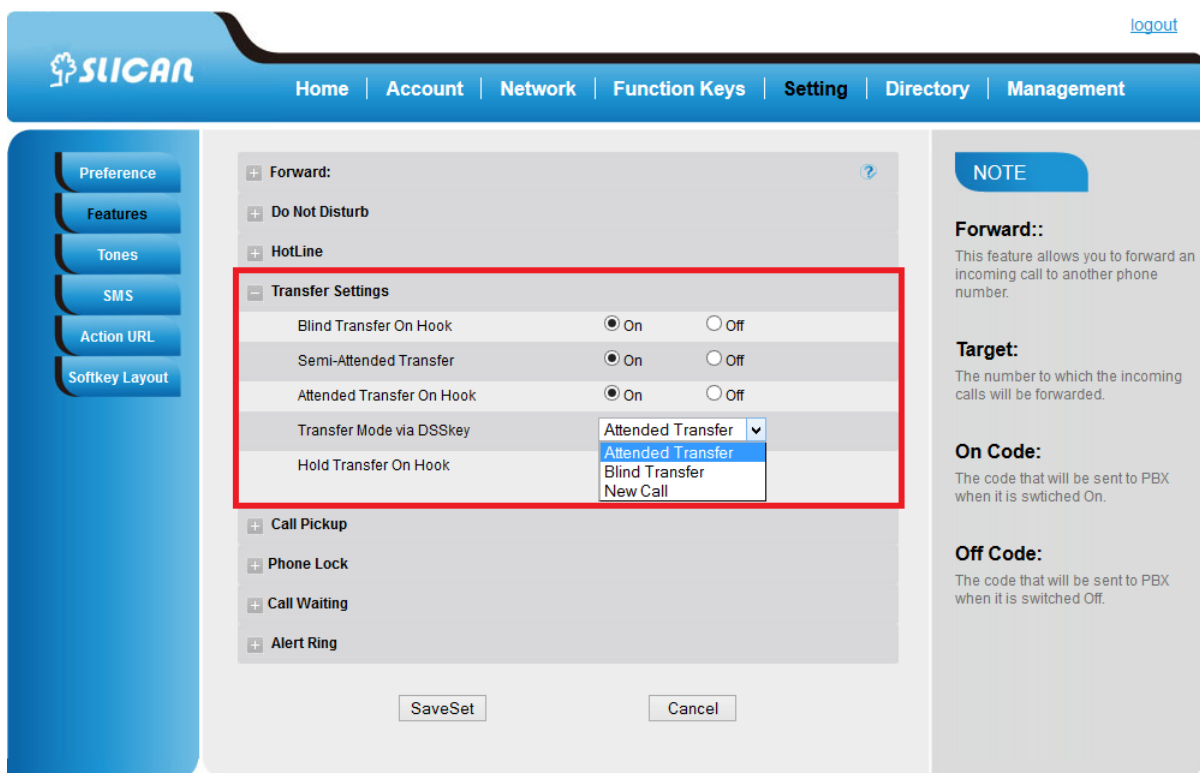

6.7. Call Conference

This IP Phone supports up to 5-way conference.



To set Conference

Assuming that call party A and B are in conversation. A wants to bring C, D and E in a conference:

1. A press line 2 key, the call is placed on hold.

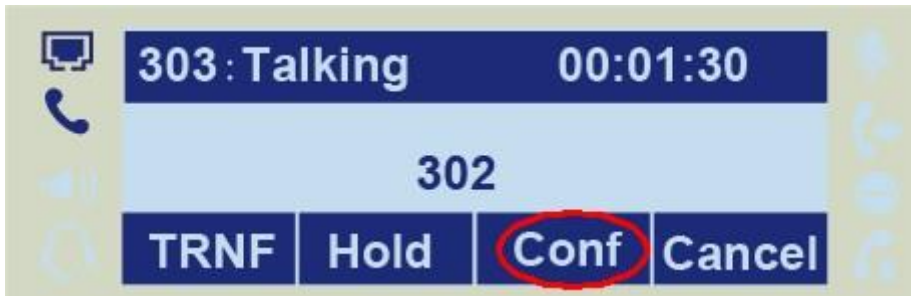
2. A enter the number of C and then press send soft key or .
3. C answering the call.
4. A press conference soft key, then A, B and C are now in a conference.(and now this is **3-way conference**)



5. A press line 3 key, the current 3-way conference is placed on hold.
6. A enter the number of D and then press send soft key or .
7. D answering the call.
8. A press the conference soft key, then A, B, C and D are now in a conference.(and now this is **4-way conference**)
9. A press line 4 key, the call is placed on hold.
10. A enter the number of E and then press send soft key or .
11. E answering the call.
12. A press the conference soft key, then A, B, C, D and E are now the **5-way conference** is built.
13. A end the call, the conference is finished.

NOTE:

1. If C does not answer the call, A can back to continue the conversation with B;
 2. Once A hangs up the call, the conference is ended, while if B or C drops the call, A&C or A&B conversation continues.
 3. The conference feature is not available on all servers. For more information, contact your system administrator.
- To realize the 5 way conference, the line should be all available.



6.8. Call Forward

This phone supports static forward (always forward, busy forward and no answer forward) and dynamic forward

To configure always forward

With this feature, all incoming calls will forward immediately to configured number.

Press: *Menu* → *Features* → *Call forward* → *Always Forward*.

Press  and  or press *info* soft key to select the enable choice.

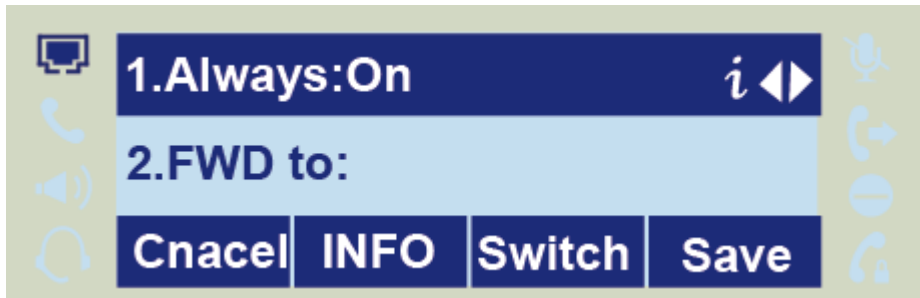

Enter the forward to number and on code (optional), off code (optional).

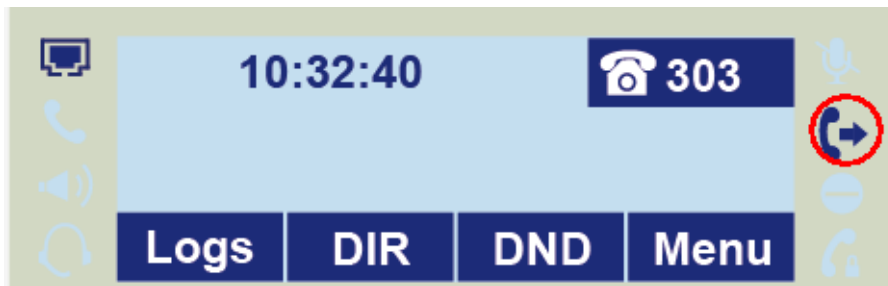

Press  or Save soft key to save the configuration.



To configure busy forward

With this feature, the incoming calls are immediately forwarded if the phone is busy.

Press: *Menu* → *Features* → *Call forward* → *Busy forward*.

Press  and  or press info soft key to select the enable choice.



Enter the forward to number and on code (optional), off code (optional).

Press  or Save soft key to save the configuration.

To configure no answer forward

No Answer Forward: Incoming calls are forwarded if not answered after some time.

Press: *Menu* → *Features* → *Call forward* → *No answer forward*.

Press  and  or press *info* soft key to select the enable choice.

Enter the forward to number and on code (optional), off code (optional).

Press  or *Save* soft key to save the configuration.

When the Forward feature is enabled, the Forward Icon will display on Top of the LCD.

To configure Forward via Web Interface

Select :Setting → Features→*Forward*.

Click on for the Always/Busy/No Answer.

Fill the Forward to Number.

Click *SaveSet* to save the configuration

[logout](#)

SLICAR Home | Account | Network | Function Keys | **Setting** | Directory | Management

Preference

Features

Tones

SMS

Action URL

Softkey Layout

Forward:

Always On Off

Target

On Code

Off Code

Busy On Off

Target

On Code

Off Code

No Answer On Off

After Ring Time(seconds)

Target

On Code

Off Code

NOTE

Forward::
This feature allows you to forward an incoming call to another phone number.

Target:
The number to which the incoming calls will be forwarded.

On Code:
The code that will be sent to PBX when it is switched On.

Off Code:
The code that will be sent to PBX when it is switched Off.

Forward an incoming call during the ringing.

When the phone is ringing, press *Forward* soft key.
Enter the forward number.

Press  or press the send soft key, then the call is forwarded.

NOTE:

If the Programmable Key or line key is set as BLF, when an incoming call ringing, press this BLF key directly to realize the dynamic forward.



6.9. Call Return - REDIAL



This feature allows you to dial the last phone call you received.

To configure the Call Return via phone interface

Press: *Menu* → *Features* → *Function Keys* → *Line* or *Memory* keys as *Function Keys* → *Memory key1*(for example)

Select the wanted Line or Memory key.

Press  and  or press info soft key to select the Key Event in the type field.

Press  and  or press info soft key to select the Call Return.

Press  or *Save* soft key to save the configuration.

To configure the Call Return via Web interface

Select: *Function keys* → *Line* or *Memory* key.

Select the desired Line or Memory key and select Call Return in the Type.



Click the *SaveSet* to save the configuration.



6.10. Anonymous Call

Just enable the anonymous call feature, you can set your ID do not appear on the other phone that you called.

To configure anonymous call

Press: *Menu* → *Features* → *Anonymous Call*

Press  and  or press info soft key to change the Line ID



Press  and  or press info soft key to select the enable choice in Anonymous Call filed.
Enter the call on code (optional), call off code (optional).



Press  or *Save* soft key to save the configuration.

Reject anonymous call

If you do not want to be disturb by anonymous calls, you can set the reject anonymous call features, so you will not hear the unknown calls

Press: *Menu* → *Features* → *Anonymous Call*

Press  and  or press *info* soft key to change the Line ID.

Press  and  or press info soft key to select the enable choice in Rejection filed.

Press  or *Save* soft key to save the configuration.

6.11. Call Mute

When you use the Mute feature, the other parties will not hear your voice while you can hear their voice. Call mute applies to all modes (handset, headset, and speakerphone).

Press the mute key , then the mute key glows green, and the LCD display Mute Icon.

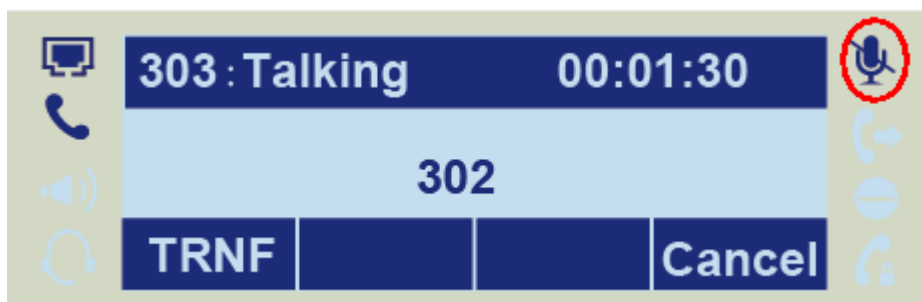

To disable the mute function, press  again.

6.12. Do Not Disturb DND

When you use the DND feature, the phone is to reject all incoming calls automatically and you can see the DND icon shown on the Top of the LCD on idle page.

To enable DND feature

Press the *DND* soft key when the phone is idle, and then DND icon shown on the LCD.

To disable DND feature

Press the *DND* soft key again, and then there is no DND icon on the LCD.

6.13. Key as Send

To speed up the process of dialing can be attribute to the end of dialing key (default #).

To configure Key as Send

Press: *Menu* → *Features* → *Key as Send*.

Press  and  or press info/switch soft key to select the enable choice.

Press  or Save soft key to save the configuration

6.14. No Key Entry Timeout

No Key Entry Timeout means that when you enter the number, it will dial out automatically after some time when you stop enter the number.

To configure No Key Entry Timeout

From WEB interface select: *Setting* → *Preference* → *NO Key Entry Timeout(seconds)*

Fill the blank of No Key Entry Timeout: for example 5(seconds).(0 means never timeout, you should press the send key the dial out the number.

Click the *SaveSet* to save the configuration.

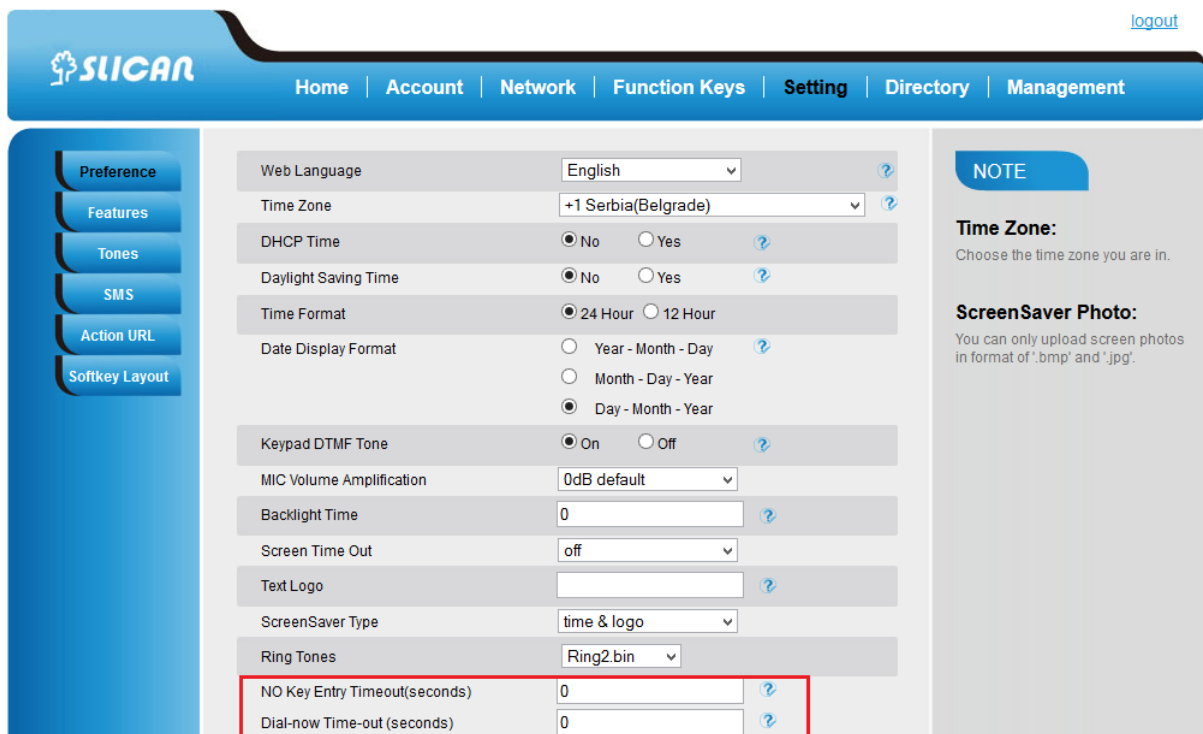

The screenshot shows the SLCAR web interface with the 'Preference' settings page. The 'NO Key Entry Timeout(seconds)' and 'Dial-now Time-out (seconds)' fields are highlighted with a red box. The interface includes a navigation menu with options like Home, Account, Network, Function Keys, Setting, Directory, and Management. A sidebar on the left lists various settings categories, and a 'NOTE' section on the right provides additional information.

Setting	Value	Help
Web Language	English	?
Time Zone	+1 Serbia(Belgrade)	?
DHCP Time	<input checked="" type="radio"/> No <input type="radio"/> Yes	?
Daylight Saving Time	<input checked="" type="radio"/> No <input type="radio"/> Yes	?
Time Format	<input checked="" type="radio"/> 24 Hour <input type="radio"/> 12 Hour	
Date Display Format	<input type="radio"/> Year - Month - Day <input type="radio"/> Month - Day - Year <input checked="" type="radio"/> Day - Month - Year	?
Keypad DTMF Tone	<input checked="" type="radio"/> On <input type="radio"/> Off	?
MIC Volume Amplification	0dB default	
Backlight Time	0	?
Screen Time Out	off	
Text Logo		?
ScreenSaver Type	time & logo	
Ring Tones	Ring2.bin	
NO Key Entry Timeout(seconds)	0	?
Dial-now Time-out (seconds)	0	?

6.15. Hot Line

The hot line gives us the opportunity to direct dialing immediately after hook off programmed number with which you want to connect to.

To configure Hot Line

Press: *Menu* → *Features* → *Hot Line*

Enter the number and delay time (as present, we support off hook auto dial).

Press  or Save soft key to save the configuration.

To configure Hotline auto dial via Web Interface

Select: *Setting* → *Features*.

Fill the number in the Hotline Number and Hotline Time-out.

Click *SaveSet* to save the configuration.

Delete the number and save the configuration, and then now the Hotline auto dial is cancelled.

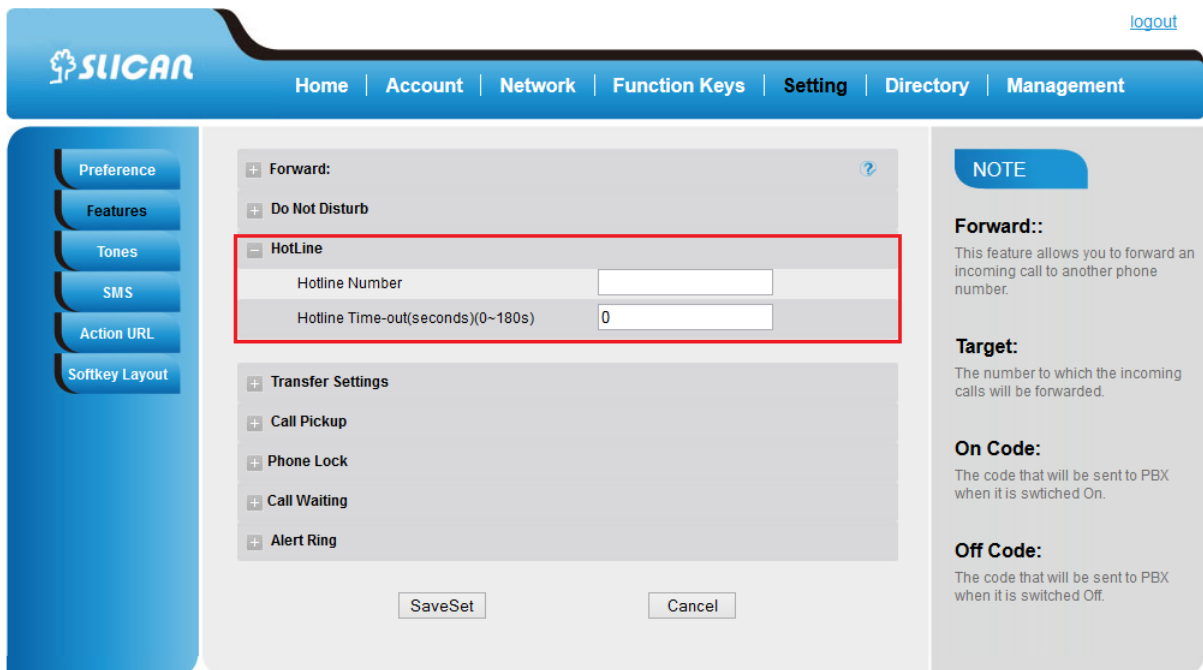

The screenshot displays the SUCAR web interface for configuring features. The 'HotLine' feature is selected and highlighted with a red border. It includes two input fields: 'Hotline Number' and 'Hotline Time-out(seconds)(0~180s)' with the value '0'. The interface also shows a 'NOTE' section on the right with details about Forward, Target, On Code, and Off Code.

7. Advanced Features

7.1. Voice Message

This phone supports Voicemail, and when there is message, the message will  will light green. Moreover, when pick up the handset, or press speaker key, you will hear some quick busy tone.

To configure the Voice mail feature

Press: *Menu* → *Messages* → *Voice Mail* → *Set Voice Mail*.

Enter the Account 1/2 NO.

Press  or *Save* soft key to save the configuration.

NOTE:



This feature is not available on all servers. For more information, contact your system administrator.

7.2. Intercom

When use the intercom feature, you can quickly get access connect to the configured one.

To configure intercom feature via phone interface

Press: *Menu* → *Features* → *Function Keys* → *Line or Memory keys as Function Keys* → *Memory key1 (for example)*

Press  and  or press info soft key to select the intercom in the type field.
Enter the targeted Number.

Press  or Save soft key to save the configuration
Then the selected Line or Memory key will work as intercom.

To configure Intercom feature via Web Interface

Select: *Function keys* → *Line or Memory key*.

Select the wanted Line or Memory key.

Enter the desired phone number in the Value field.

Select the Account ID

Click the *SaveSet* to save the configuration.

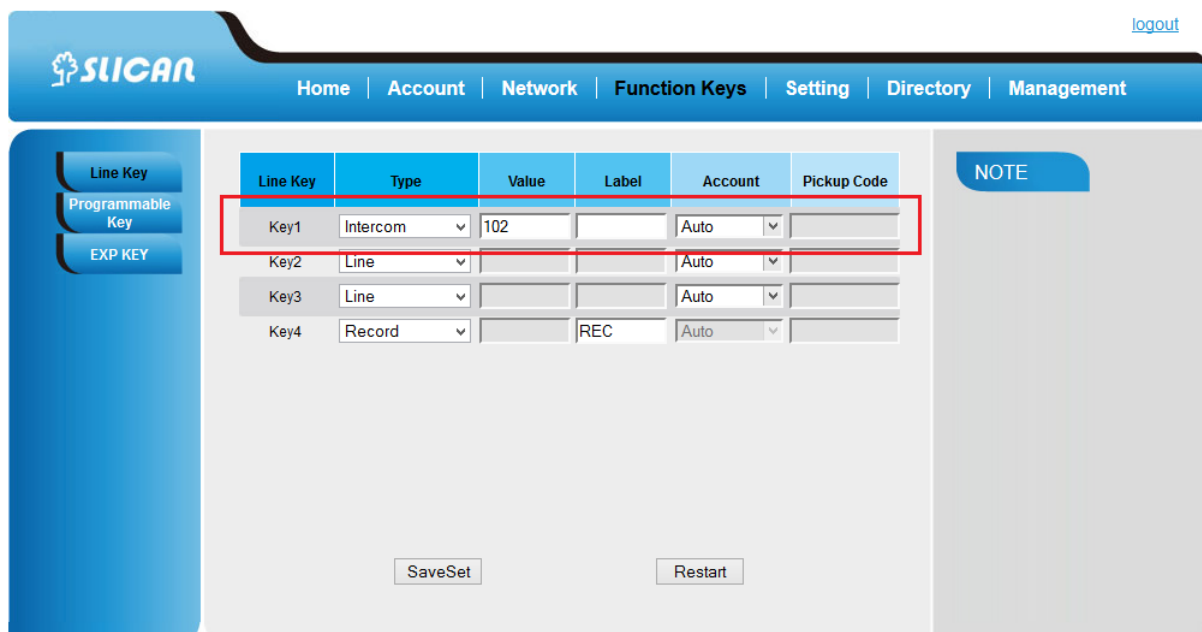

Line Key	Type	Value	Label	Account	Pickup Code
Key1	Intercom	102		Auto	
Key2	Line			Auto	
Key3	Line			Auto	
Key4	Record		REC	Auto	

NOTE:



This feature is not available on all servers. For more information, contact your system administrator.

7.3. Speed Dial Direct Pickup

With this feature, you can dial one directory by press the definite key.

To configure Speed Dial feature via phone interface

Press: *Menu* → *Features* → *Function Keys* → *Line* or *Memory keys* as *Function Keys* → *Memory key1* (for example)

Press  and  or press info soft key to select the Speed Dial in the type field.
Enter the targeted Number.

Press  or Save soft key to save the configuration
Then the selected Line or Memory key will work as Speed Dial.

To configure Speed Dial feature via Web Interface

From WEB interface select: *Function keys* → *Line* or *Memory key*.

Select the wanted Line or Memory key and set as Speed Dial.

Enter the desired phone number in the Value field.

Select the Account ID



Click the *SaveSet* to save the configuration.

7.4. Direct Pickup

With this feature, you can pick up the set line when it ringing.

To configure Direct Pickup feature via phone interface

Press: *Menu* → *Features* → *Function Keys* → *Line* or *Memory keys* as *Function Keys* → *Memory key1* (for example)

Press  and  or press  key to select the Speed Dial in the type field.
Enter the value.

Press  or Save soft key to save the configuration
Then the selected Line or Memory key will work as Direct Pickup.

To configure Direct Pickup feature via Web Interface

From WEB interface select: *Function keys* → *Line* or *Memory key*.

Select the wanted Line or Memory key and set as Direct Pickup.

Enter the pickup code and followed the desired phone number in the Value field.

Select the Account ID.

Click the *SaveSet* to save the configuration.



7.5. Group Pickup

With this feature, you can pick up the specified group that you want incoming calls.

To configure the Pick up via phone interface

Press: *Menu* → *Features* → *Function Keys* → *Line* or *Memory keys* as *Function Keys* → *Memory key1* (for example)

Select the wanted Line or Memory key.

Press  and  or press info soft key to select the Group Pickup in the type field.
Enter pickup code and followed the desired group numer.

Press  or Save soft key to save the configuration

Konfiguracja odbierania grupy poprzez interfejs webowy

From WEB interface select: *Function Keys* → *Line Key1* → *Key1*.

Select the wanted Line or Memory key.

Enter pickup code and followed the desired group numer.

Click the *SaveSet* to save the configuration.

7.6. BLF(Busy Lamp Field)

You can use the BLF (Busy Lamp Field) feature to monitor a specific numer whether its phone is busy or free.



When the monitored line is idle, the LED is solid green. When the monitored line is ringing, the light is blinking red, press the BLF key to pick the phone up directly. When the monitored line is calling or in a conversation, the light is steady red.

Optionally, this function gives us the ability to intercept calls to the monitored number with code capture.



To configure a BLF key by phone

Press: *Menu* → *Features* → *Function Keys* → *Line* or *Memory keys* as *Function Keys* → *Memory key1*(for example).

Select the targeted Line or Memory key.

Press  and  or press infos soft key to select the BLF in the type field.

Enter the targeted Value Number.

Press  and  or press infos soft key to select the BLF in the type field.

Enter the Pickup Code.

Press  or Save soft key to save the configuration

To configure a BLF key by web

Select: *Function keys* → *Line* or *Memory key*.

Select the desired Line or Memory key and select BLF in the Type.

Enter the monitored phone number in the Value field.

Select the Account ID.

Filled the Pickup code.

Click the *SaveSet* to save the configuration and then restart.

[logout](#)

SUCAR Home | Account | Network | **Function Keys** | Setting | Directory | Management

Line Key

Memory Key

Programmable Key

Memory Key	Type	Value	Account	Pickup Code
Key1	BLF		Account 1	
Key2	N/A		Account 1	
Key3	N/A		Account 1	
Key4	N/A		Account 1	
Key5	N/A		Account 1	

NOTE

Key Type:
The free function key Type Speed Dial,BLF,Key Event,intercom,URL.

BLF:
BLF setting require a phone restart

NOTE:

This feature is not available on all servers. For more information, contact your system administrator.

7.7. Shared Line

This feature allows subscribers to share SIP lines. Moreover it also provides status monitoring of the shared line.

To configure the line key as shared line via phone interface

Press: *Menu* → *Features* → *Function Keys* → *Line* or *Memory keys as Function Keys* → *Memory key1* (for example)

Select the wanted Line or Memory key.

Press and or press info soft key to select the Shared Line in the type field.

Press and or press info soft key to select the Account ID.

Enter the Label.

Enter the Value.

Press or Save soft key to save the configuration.

To configure the line key as shared line via Web Interface

From WEB interface select: *Function keys* → *Line Key* or *Memory key*.

Select the desired Line or Memory key and select Shared Line in the Type.

Enter the Value.

Enter the Label.

Select the Account ID

Click the *SaveSet* to save the configuration and then restart.

[logout](#)

SLICAR Home | Account | Network | **Function Keys** | Setting | Directory | Management

Line Key

Memory Key

Programmable Key

Memory Key	Type	Value	Account	Pickup Code
Key1	Shared Line		Account 1	
Key2	N/A		Account 1	
Key3	N/A		Account 1	
Key4	N/A		Account 1	
Key5	N/A		Account 1	

NOTE

Key Type:
The free function key Type Speed Dial,BLF,Key Event,intercom,URL.

BLF:
BLF setting require a phone restart

NOTE:
This feature is not available on all servers. For more information, contact your system administrator.



7.8. Call Park



With this feature, you can put a call on hold and continue the conversation from another phone.

To configure the Call Park via phone interface

Press : *Menu* → *Features* → *Function Keys* → *Line* or *Memory keys as Function Keys* → *Memory key1* (for example)

Select the wanted Line or Memory key.

Press  and  or press Switch soft key to select the Key Event in the type field.

Press  and  or press Switch soft key to select the Call Park.

Press  or *Save* soft key to save the configuration.

To configure the Call Park via Web interface

From WEB interface select: *Function key* → *Line* or *Memory key*.

Select the desired Line or Memory key and select Direct Pickup in the Type.

Click the SaveSet to save the configuration.



7.9. Paging



With this feature, you can call a phone directly.

To configure the paging via phone interface

Press: *Menu* → *Features* → *Function Keys* → *Line* or *Memory keys as Function Keys* → *Memory key1* (for example)

Select the wanted Line or Memory key.

Press  and  or press info soft key to select the Key Event in the type field.

Press  and  or press info soft key to select the Paging.

Press  or Save soft key to save the configuration

To configure the Paging via Web interface

Select: *Function keys* → *Line or Memory key*.

Select the desired Line or Memory key and select Paging in the Type.

Click the *SaveSet* to save the configuration.



7.10. DTMF

This feature allows you to send directly to the DTMF signaling lines during an ongoing call.

To configure the DTMF via Phone Interface

Press: *Menu* → *Features* → *Function Keys* → *Line or Memory keys as Function Keys* → *Memory key1*
(for example)

Select the wanted Line or Memory key.

Press  and  or press info soft key to select the DTMF in the type field.

Enter the value.

Press  or Save soft key to save the configuration

To configure the DTMF via Web interface

Click *Function keys* → *Line or Memory key*.

Select the desired Line or Memory key and select DTMF in the Type.

Fill the value.

Click the *SaveSet* to save the configuration.



7.11. Prefix

This feature allows us to define any prefix added before the dialed number.

To configure the Prefix via Phone Interface

Press: *Menu* → *Features* → *Function Keys* → *Line or Memory keys as Function Keys* → *Memory key1*
(for example)

Select the wanted Line or Memory key.

Press  and  or press info soft key to select the Prefix in the type field.

Enter the value.

Press  or *Save* soft key to save the configuration.

To configure the Prefix via Web interface

Select: *Function key* → *Line or Memory key*.

Select the desired Line or Memory key and select Prefix in the Type.

Fill the value.

Click the *SaveSet* to save the configuration.

Then when you press this key, the set value is input directly.

7.12. Action URL

This feature allows us to send useful information from the phone to the server and vice versa in order to initiate certain actions on the phone.

This gives us the opportunity to observe phone status or sending such requests:

- login / logout phone
- hook on/hook off handset
- make a call
- turn on DND service

An example of the syntax of the call from the phone by account number 1 to number 523 251 111:

[http://admin:password@
IP-Address/Phone_ActionURL&Command=1&Number=523251111&Account=1](http://admin:password@IP-Address/Phone_ActionURL&Command=1&Number=523251111&Account=1)

7.13. Keyboard Layout

Ta opcja pozwala na definiowanie stanu wyświetlania klawiszy podczas danej akcji np. wybieranie lub rozmowa. Definiujemy wówczas jakie funkcje ma dany klawisz wykonać.

7.14. Keypad Lock

Phone lock feature allows us to completely block the function or the function keys.

To enable Keypad Lock via Phone

Press: *Menu* → *Settings* → *Advanced Setting* → *Phone Setting* → *Lock*

Press: *Info* or *Switch* to change choose lock type: All Keys Menu Key Function Key Lock & Answer
Press *Save* or OK key to save the configuration.

To disable Keypad Lock via Phone

Press: *Menu* → *Settings* → *Advanced Setting* → *Phone Setting* → *Lock*.

Press: *Info* or *Switch* to change choose Off.

Press *Save* or OK key to save the configuration.

To enable Keypad Lock via Webpage

From WEB interface: *Setting* → *Preference*.

To choose the Lock keys.

To fill the unlock PIN and auto lock time

Fill the Emergence Number, when the phone is Lock, only Emergency Number can be sent.

To click *Saveset* to save the configuration..

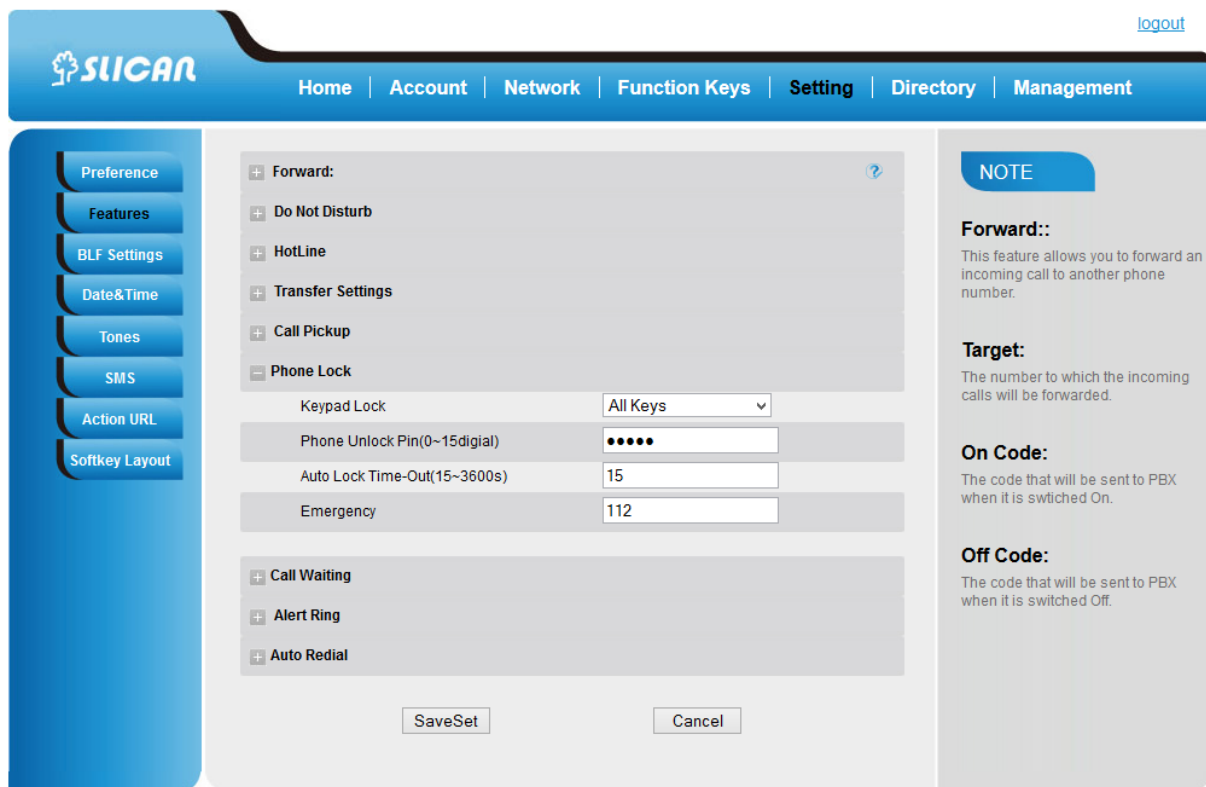

8. Management – Upgrade

8.1. Start

Login window startup web interface gives us a phone the most important status such as:

- product model
- firmware Version
- account status
- network status: address IP, DNS, MAC address
- memory free
- system up time

8.2. Factory Reset

It enables us to reset all phone settings to default factory settings.

To set Factory Reset by phone interface

Press: *Menu* → *Setting* → *Advanced Setting* (default password: *admin*) → *Phone Setting* → *Factory Reset*
Press OK soft key in the warning page.

To set Factory Reset via web interface

Select: *Management* → *Upgrade* → *Reset To Factory*.

[logout](#)

SLICAR Home | Account | Network | Function Keys | Setting | Directory | Management

- Password
- Upgrade
- Auto Provision
- Configuration
- Trusted CA
- Server CA
- Tools
- Restart
- Reboot

- Image Version

Major Version	IMG--1.0.3.77(2015-01-29 11:30:00)
Minor Version	IMG--1.0.3.74(2014-12-22 18:17:00)

 - **Reset To Factory**
 - ROM Firmware Upgrade Nie wybrano plik

NOTE

Image Version:
Show the information of the two system image version .

Reset To Factory :
Reset all the settings of the phone to default configurations.

Restart:
one simple operation for restart the voip application.

8.3. Software update

The software update can be done in several ways:

- via TFTP server(specify the path).
- through auto-provisioning server HTTP / HTTPS
- by selecting the firmware image file from the specified location (local or network drive)

Configuring the TFTP/HTTP Server

It is recommended to set the TFTP server address in either a public IP address or on the same LAN with the phone.

To configure the TFTP server via the Web configuration interface

Press: *Menu* → *Setting* → *Advanced setting*(default password: *admin*) → *Phone setting* → *Auto Provision* → *Upgrade Mode*(TFTP/HTTP).

Then enter the address of the TFTP server / HTTP for that purpose field. After entering the TFTP/HTTP configuration reset the phone.

To configure the TFTP server via the Web configuration interface

Select: *Management* → *Auto Provision* → *Upgrade Mode*(TFTP/HTTP) → *Firmware Server Path*.

TFTP process may take as long as 1 to 2 minutes over the Internet or just 20+ seconds if it is performed on a LAN. Users are recommended to conduct TFTP upgrade in a controlled LAN environment if possible. Katalog konfiguracji lokalnego TFTP.

Directory to configure local TFTP/HTTP

Unzip the file and put all of them under the root directory of the TFTP server.

The PC running the TFTP server and the VPS PHONE should be in the same LAN segment

Select: *Management* → *Auto Provision* → *Upgrade Mode*(TFTP/HTTP) → *Firmware Server Path*.

Configure the path to the update server by entering the IP address and the destination folder. Update the change and reboot the unit.

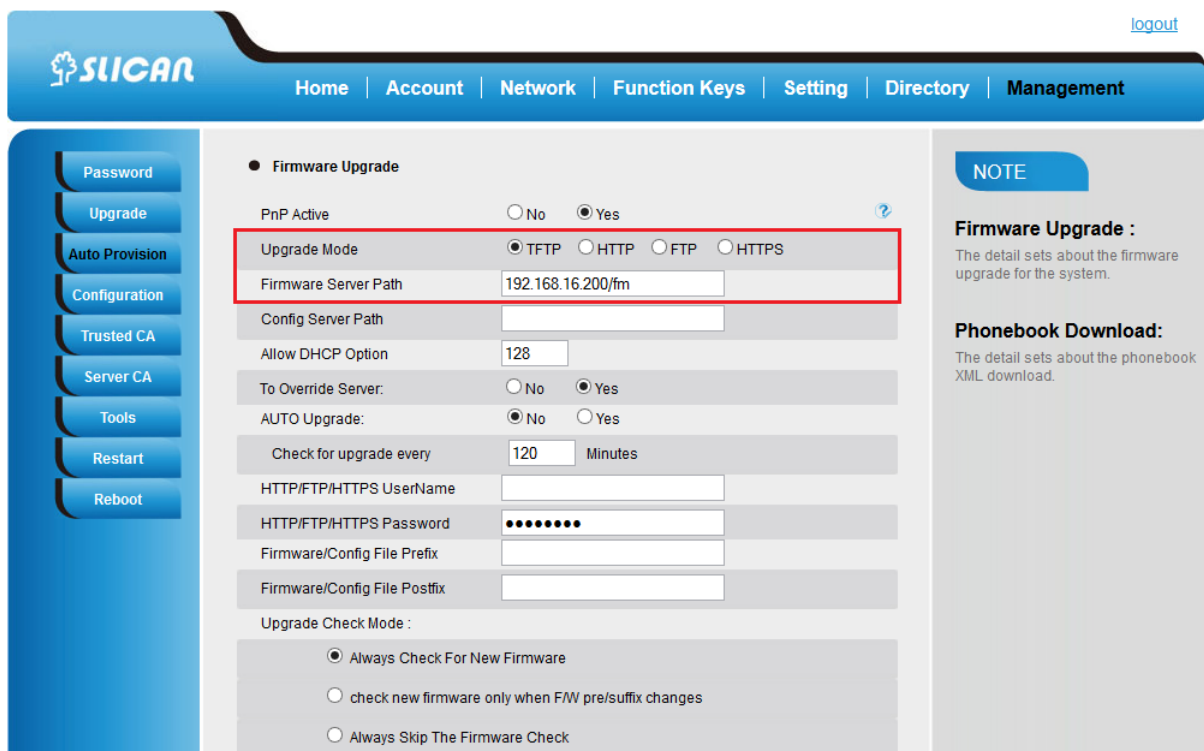

Autoprovisioning HTTP/HTTPS

Automatic update method configuration functionality is available as a server. The system administrator knowing the specific data of the phone, ie.: MAC address, prepares the server level preconfiguration file that is downloaded on the phone while its initialization (reboot).

To upgrade manually via the Web configuration interface

This option gives us the opportunity to update manually the phone software from the image file. From WEB interface: *Management* → *Upgrade* → *Img Firmware Upgrade* → *Upgrade*.

Downloading device configuration

This functionality allows you to import the current configuration of the phone in two formats:

- as a BIN(binary) file
- with an extension of XML

From WEB interface: *Management* → *Configuration* → *Download Device BIN/XML Configuration*.

You can also restore the configuration using the following options:

Select: *Zarządzanie* → *Konfiguracja* → *Retore Configuration XML/BIN*.

8.4. Remote Phonebook

Phone support ability download remote phonebook.

From WEB interface: *Management* → *Auto Provision* → *Phonebook XML Download*

In this case, you must specify the access path to the resource phonebook on the server (IP address / domain directory).

There is two method:

- manually (specify server path)

From WEB interface: *Management* → *Auto Provision* → *Phonebook XML server path*

- vai auto-provisioning

From WEB interface: *Management* → *Auto Provision* → *Phonebook Download Enable (HTTP/HTTPS)*

8.5. System Log

The aim diagnose problems with your phone can download the system log as a text file or define the server on which the logs are to be sent.

We set the levels collecting logs as a: DEBUG, INFO, WARNING, ERROR.

The phone also allows network log collection as a "pcap" file.

This is usefull functionality for system administrator to analyze network problems.

From WEB interface: *Management* → *Upgrade* → *PCAP Feature*.

8.6. TLS Certificates

Certificate authentication for connections to a trusted server.

9. Troubleshooting

9.1. Why is the phone LCD screen blank?

Ensure your phone is properly plugged into a functional AC outlet.

Ensure that the phone isn't plugged into a plug controlled by a switch that is off.

If the phone is plugged into a power strip, try plugging it directly into a wall outlet instead.

If your phone is powered from PoE, ensure you use a PoE compliant switch or hub, or contact your system administrator for more information.

Check that the power LED is on to ensure the phone is powered on.

Otherwise, contact your system administrator.

9.2. Why does the phone display "Network Unavailable"?

Ensure that the Ethernet cable is plugged into the Internet port on the phone and the Ethernet cable is not loose.

Ensure that the switch or hub in your network is operational.

Otherwise, contact your system administrator.

9.3. Why can't I get a dial tone?

Check for any loose connections and that the phone has been installed properly. For the Installation instructions, refer to [Phone Installation](#).

Check whether dial tone is present on one of the audio modes.

Switch between the Handset, Headset (if present) or Hands-Free Speakerphone to check whether dial tone is present for one of the audio modes.

If the dial tone exists on another audio mode, connect a different handset or headset to isolate the problem.

Otherwise, contact your system administrator.

10. Annex

10.1. Technical Specifications

COMPONENT	SPECIFICATION
Power Adapter	Input: 100-240V AC 50-60Hz Output: 5V/1.2A DC
Network ports	Internet: 10/100 Base-T RJ-45(WAN/LAN) PC: 10/100 Base-T RJ-45 (LAN)
Additional socket	Headset: RJ-9(4P4C)
LCD Display	128 × 40 mm, Pixel matrix LCD
Operating temperature	-10~50°C
Humidity	10 ~ 95%
Weight	0,48kg

10.2. Voice Parameters

- Volume control
- Ring tone selection/Import/Delete
- MIC gain
- Voice Activity Detection(VAD),
- G.722. HD Codec, HD speaker, HD handset
- Full-duplex speakerphone with AEC
- Comfort Noise Insertion CNI
- Acoustic Echo Cancelation(AEC),
- DTMF(In-Band, RFC2833, SIP Info)

10.3. Network Parameters

- WAN/LAN: obsługa trybu Bridge i Router
- Obsługa NAT i NAPT
- Static/DHCP/PPPoE
- VLAN QoS (802.1pq)
- TCP, UDP, ICMP, RARP, ARP, DNS, NTP,SNTP
- VPN (L2TP, UDP)
- TFTP/DHCP/PPPoE client
- Layer 3 (ToS, DiffServ, MPLS) QoS